



Campi Elettromagnetici

Corso di Laurea in Ingegneria Informatica, Biomedica e delle
Telecomunicazioni

a.a. 2019–2020 – Laurea “Triennale” – Secondo semestre – Secondo anno

Università degli Studi di Napoli “Parthenope”

Stefano Perna

Maxwell equations: Time domain, Frequency domain, Phasors



Frequency domain

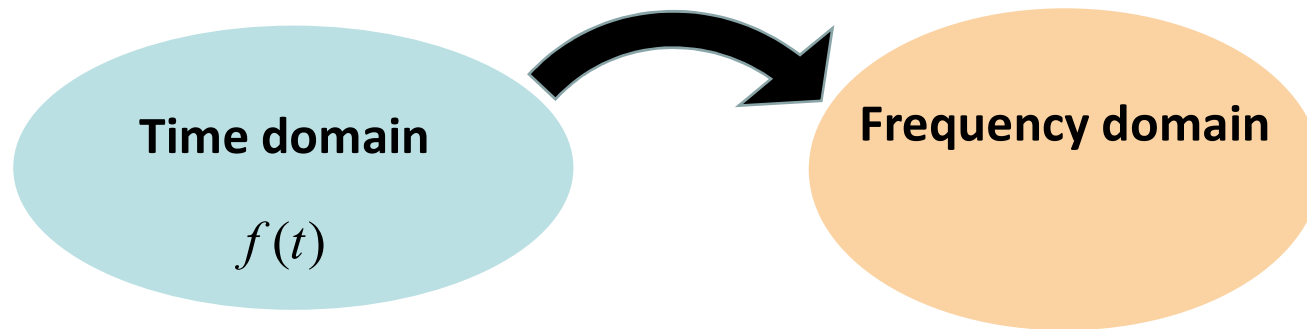

Frequency domain

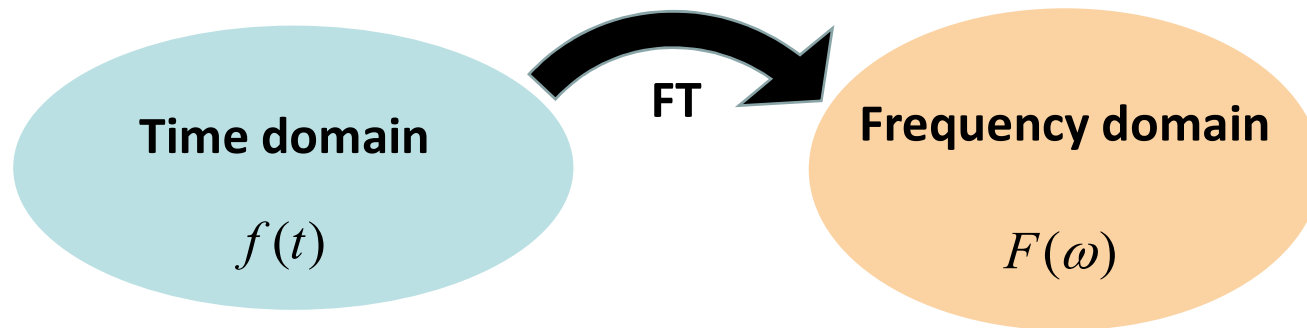

$$F(\omega) = \int_{-\infty}^{+\infty} f(t) e^{-j\omega t} dt$$

Fourier Transform (FT)

Frequency domain

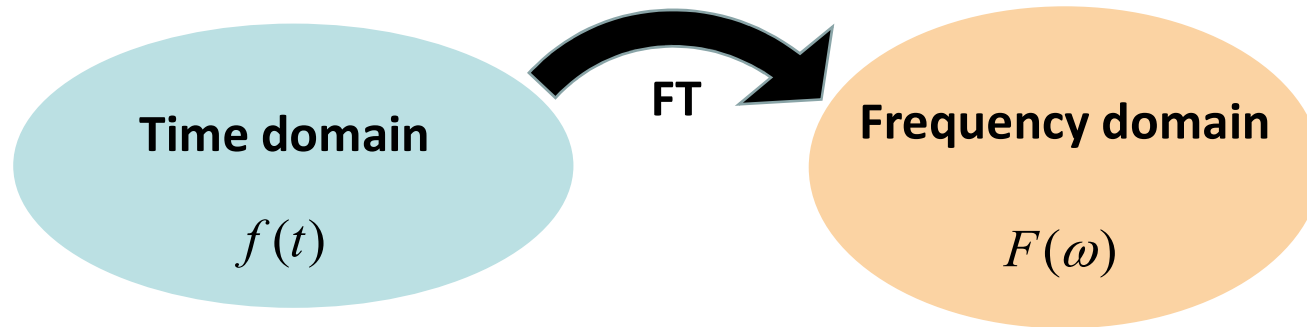

$$F(\omega) = \int_{-\infty}^{+\infty} f(t) e^{-j\omega t} dt$$

Fourier Transform (FT)

- 1) How to jump back from the Frequency domain to the Time domain
- 2) Time domain derivative and Fourier Transform

Frequency domain

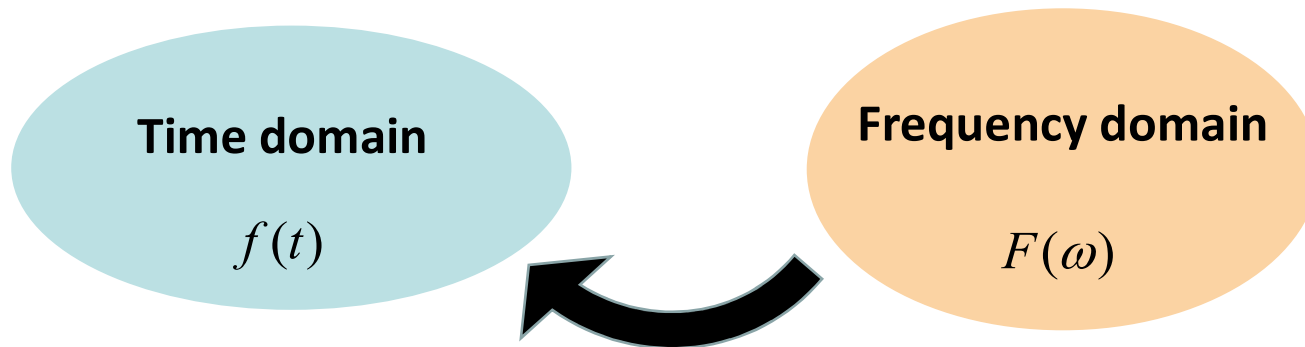

$$F(\omega) = \int_{-\infty}^{+\infty} f(t) e^{-j\omega t} dt$$

Fourier Transform (FT)

1) How to jump back from the Spectral domain to the Time domain

Frequency domain

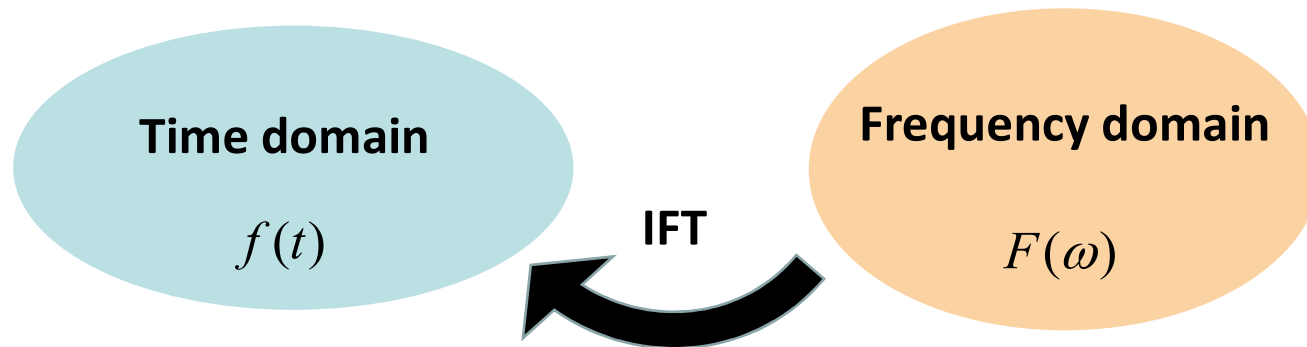

$$F(\omega) = \int_{-\infty}^{+\infty} f(t) e^{-j\omega t} dt$$

Fourier Transform (FT)

1) How to jump back from the Spectral domain to the Time domain

$$f(t) = \frac{1}{2\pi} \int_{-\infty}^{+\infty} F(\omega) e^{j\omega t} d\omega$$

Inverse Fourier Transform (IFT)

Frequency domain

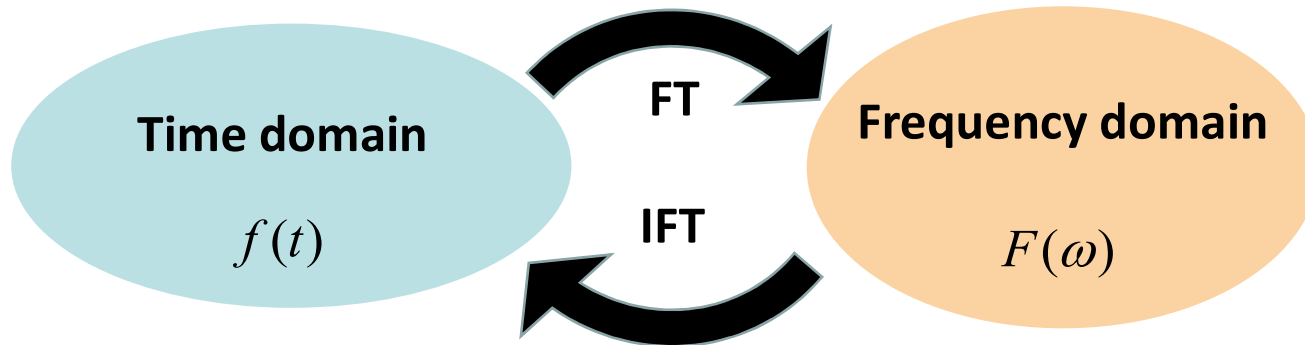

$$f(t) \longrightarrow \boxed{\text{FT}} \longrightarrow F(\omega) = \int_{-\infty}^{+\infty} f(t) e^{-j\omega t} dt$$

$$F(\omega) \longrightarrow \boxed{\text{IFT}} \longrightarrow f(t) = \frac{1}{2\pi} \int_{-\infty}^{+\infty} F(\omega) e^{j\omega t} d\omega$$

Frequency domain

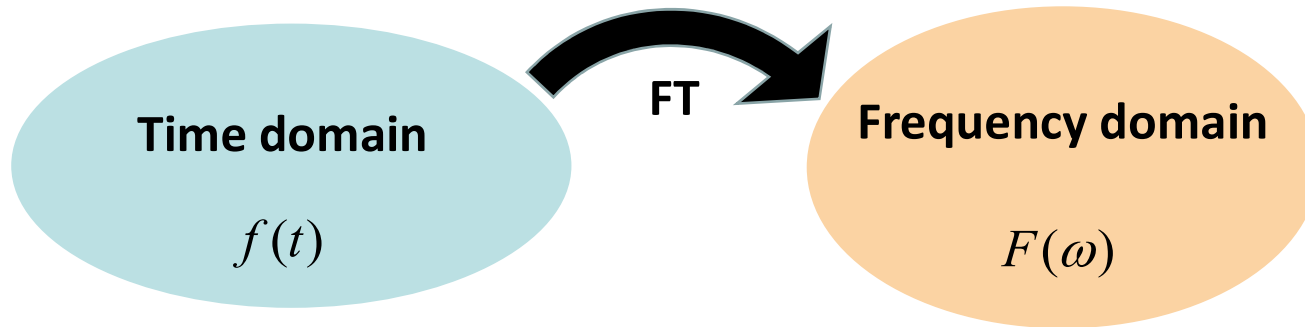

$$F(\omega) = \int_{-\infty}^{+\infty} f(t) e^{-j\omega t} dt$$

Fourier Transform (FT)

2) Time-domain derivative and Fourier Transform



Frequency domain

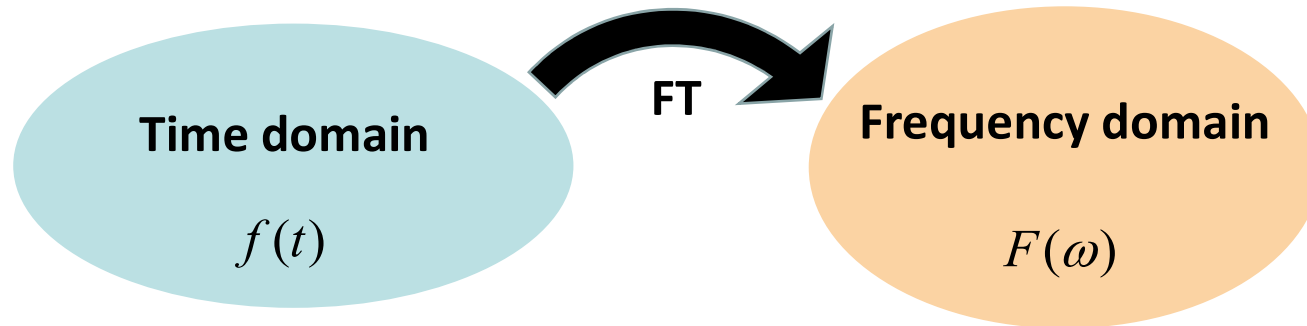

$$F(\omega) = \int_{-\infty}^{+\infty} f(t) e^{-j\omega t} dt$$

Fourier Transform (FT)

2) Time-domain derivative and Fourier Transform

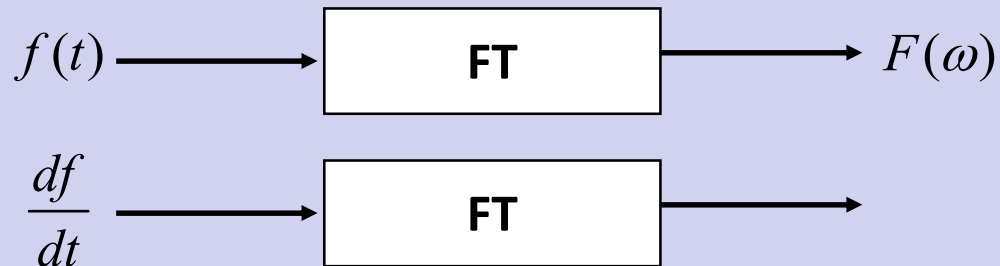

Frequency domain

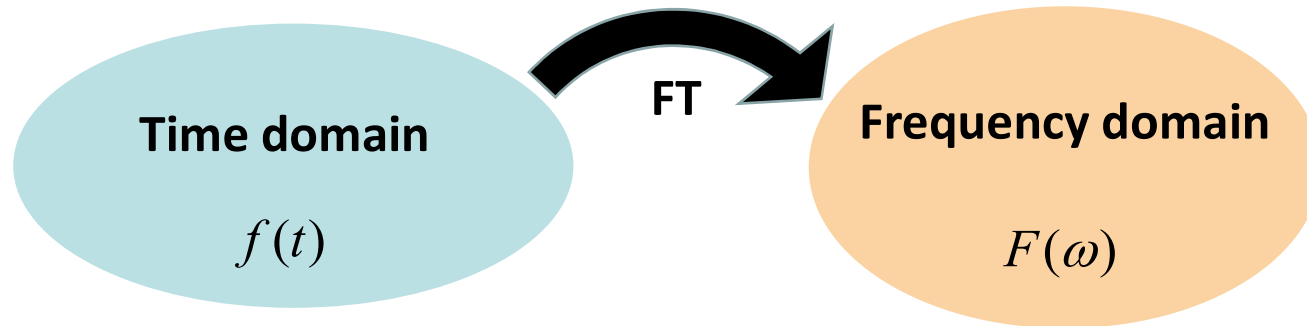

$$F(\omega) = \int_{-\infty}^{+\infty} f(t) e^{-j\omega t} dt$$

Fourier Transform (FT)

2) Time-domain derivative and Fourier Transform

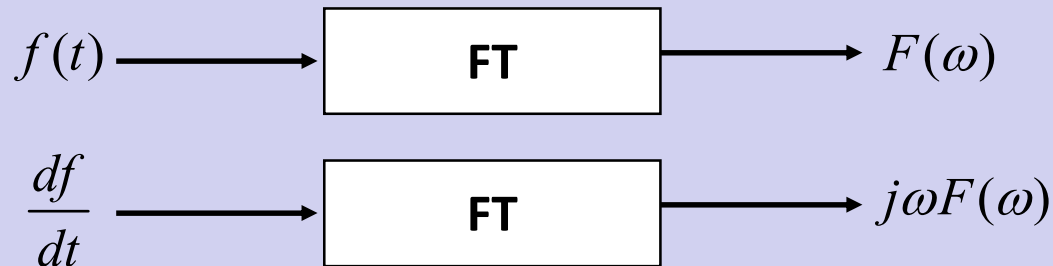

Frequency domain

- **Fourier Transform and functions of n variables**
- **Fourier Transform and vector functions**
- **Fourier Transform and vector functions of n variables**

Frequency domain

- **Fourier Transform and functions of n variables**
- **Fourier Transform and vector functions**
- **Fourier Transform and vector functions of n variables**

- 1) **How to jump back from the Frequency domain to the Time domain**
- 2) **Time domain derivative and Fourier Transform**

Frequency domain

- **Fourier Transform and functions of n variables**
- Fourier Transform and vector functions
- Fourier Transform and vector functions of n variables

- 1) **How to jump back from the Frequency domain to the Time domain**
- 2) **Time domain derivative and Fourier Transform**

Fourier Transform and functions of n variables

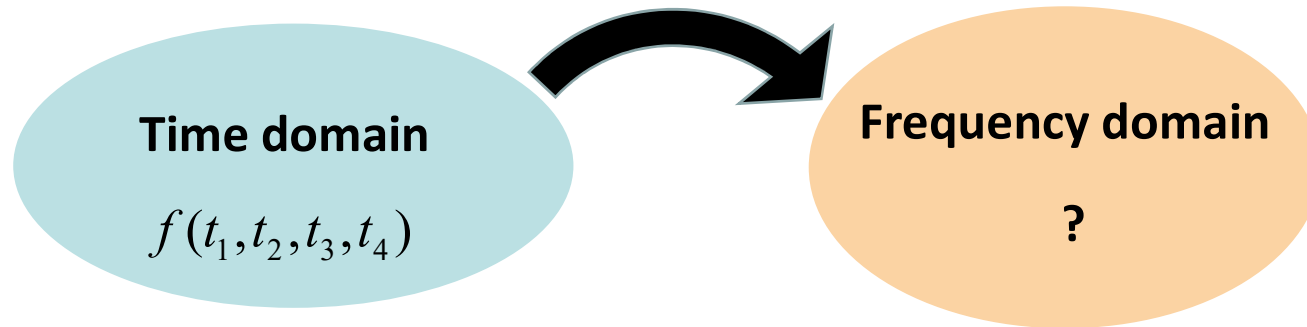

Fourier Transform and functions of n variables

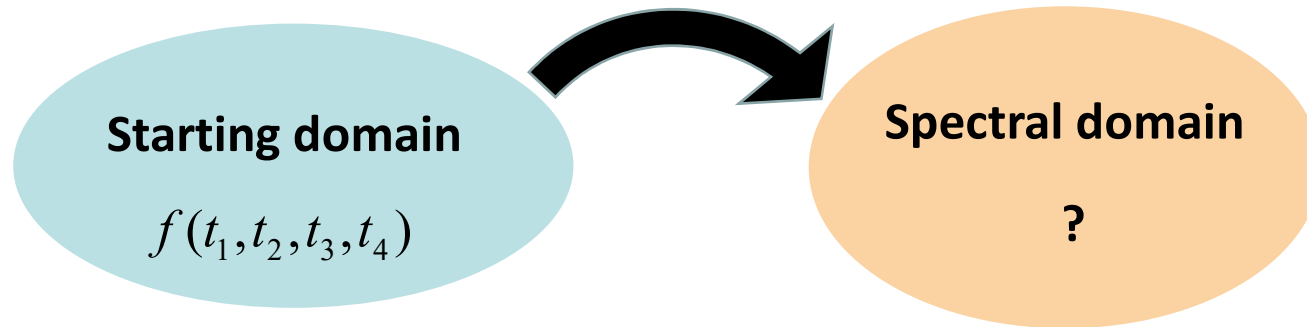

Fourier Transform and functions of n variables

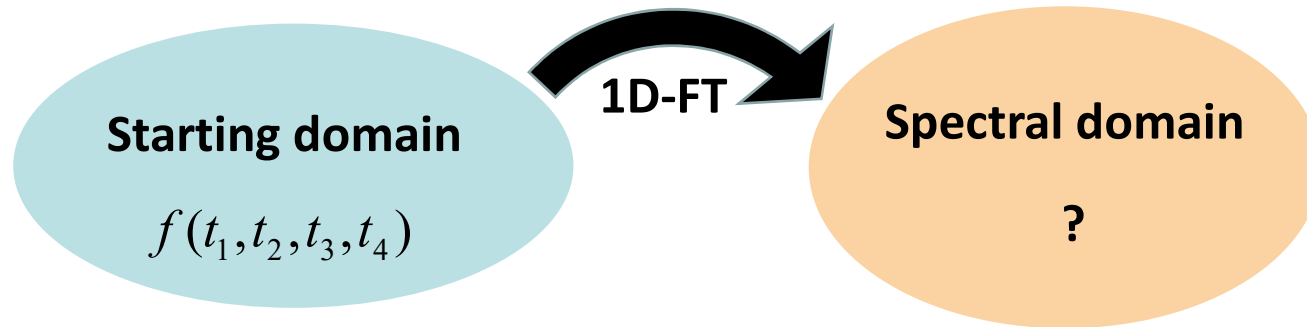

One Dimensional Fourier Transform (1D-FT)

Fourier Transform and functions of n variables

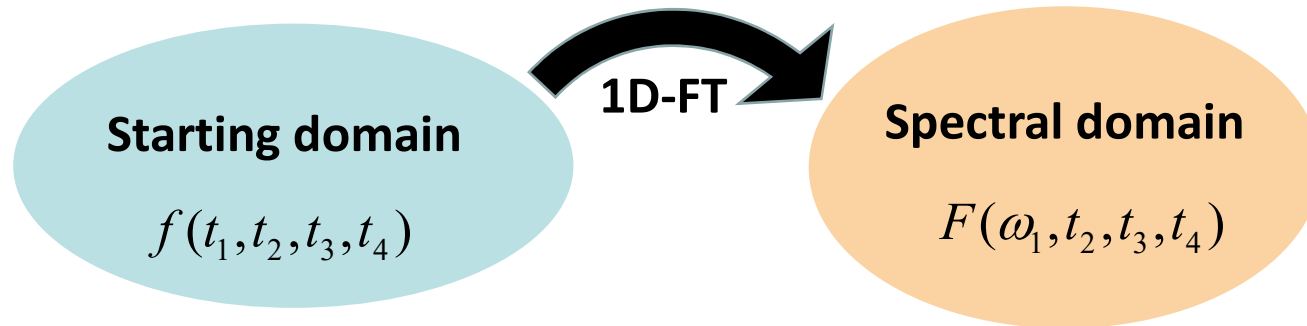

One Dimensional Fourier Transform (1D-FT)

$$F(\omega_1, t_2, t_3, t_4) = \int_{-\infty}^{+\infty} f(t_1, t_2, t_3, t_4) e^{-j\omega_1 t_1} dt_1$$

Fourier Transform and functions of n variables

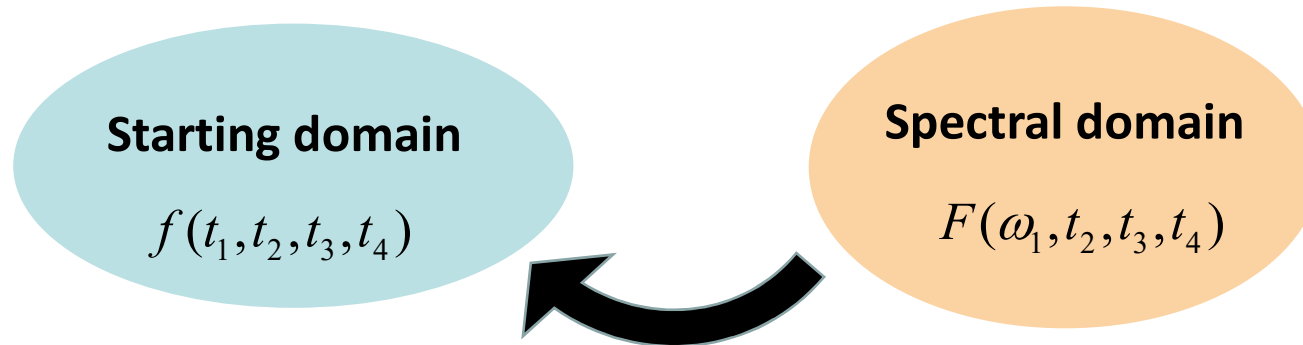

One Dimensional Fourier Transform (1D-FT)

$$F(\omega_1, t_2, t_3, t_4) = \int_{-\infty}^{+\infty} f(t_1, t_2, t_3, t_4) e^{-j\omega_1 t_1} dt_1$$

1) How to jump back from the Spectral domain to the Time domain

Fourier Transform and functions of n variables

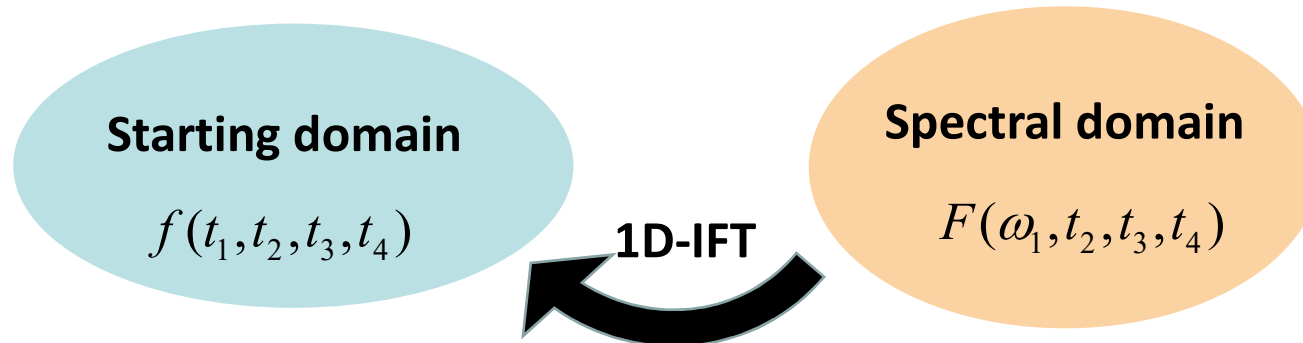

One Dimensional Fourier Transform (1D-FT)

$$F(\omega_1, t_2, t_3, t_4) = \int_{-\infty}^{+\infty} f(t_1, t_2, t_3, t_4) e^{-j\omega_1 t_1} dt_1$$

1) How to jump back from the Spectral domain to the Time domain

$$f(t_1, t_2, t_3, t_4) = \frac{1}{2\pi} \int_{-\infty}^{+\infty} F(\omega_1, t_2, t_3, t_4) e^{j\omega_1 t_1} d\omega_1 \quad \text{1D-IFT}$$

Fourier Transform and functions of n variables

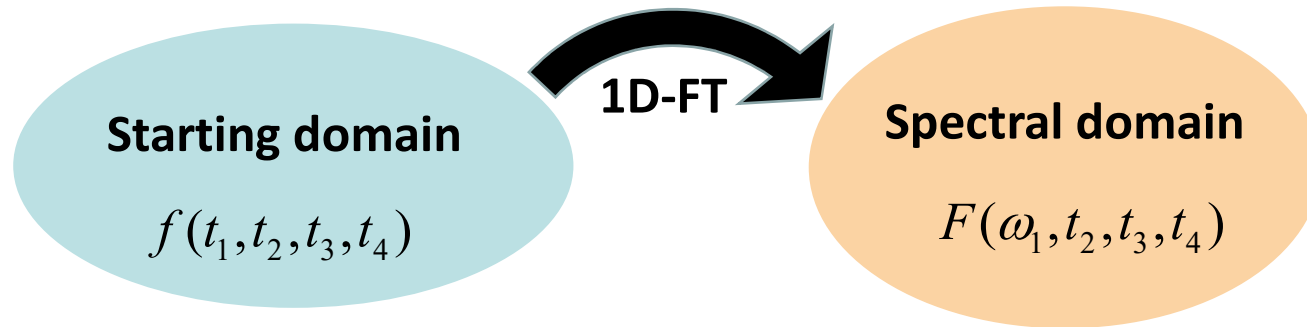

$$f(t_1, t_2, t_3, t_4) \xrightarrow{\text{1D-FT}} F(\omega_1, t_2, t_3, t_4) = \int_{-\infty}^{+\infty} f(t_1, t_2, t_3, t_4) e^{-j\omega_1 t_1} dt_1$$

$$F(\omega_1, t_2, t_3, t_4) \xrightarrow{\text{1D-IFT}} f(t_1, t_2, t_3, t_4) = \frac{1}{2\pi} \int_{-\infty}^{+\infty} F(\omega_1, t_2, t_3, t_4) e^{j\omega_1 t_1} d\omega_1$$

Fourier Transform and functions of n variables

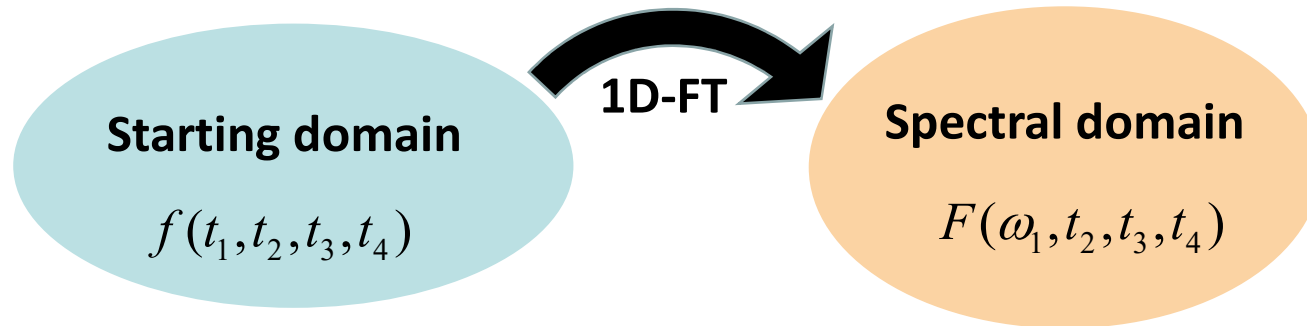

2) Time domain derivative and Fourier Transform

Fourier Transform and functions of n variables

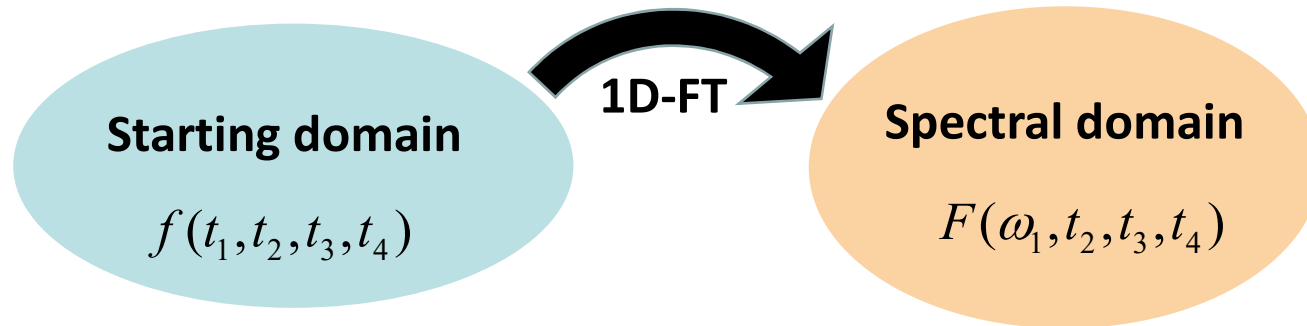

2) Time domain derivative and Fourier Transform



Fourier Transform and functions of n variables

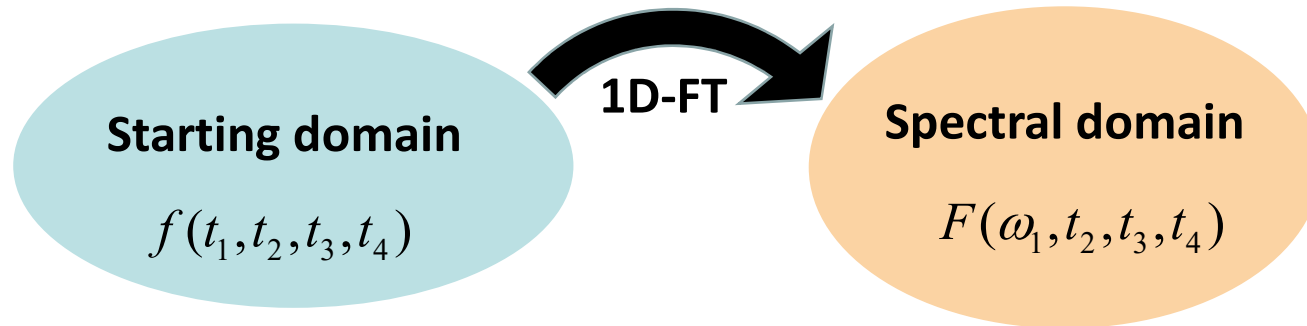

2) Time domain derivative and Fourier Transform

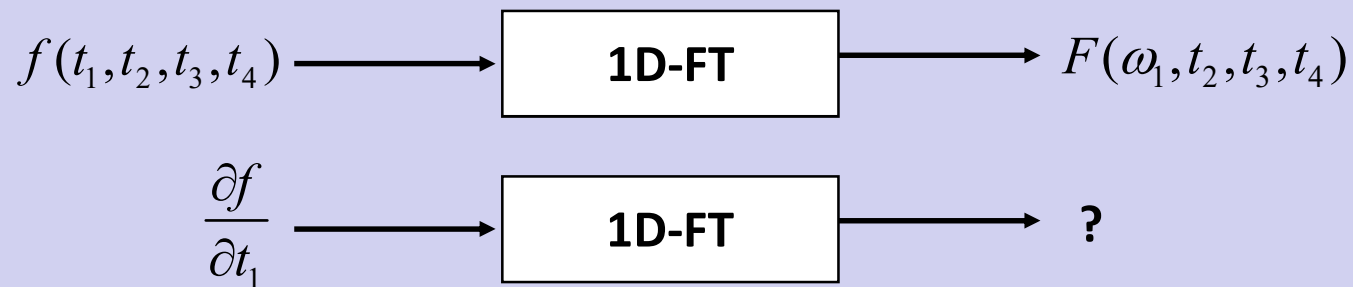

Fourier Transform and functions of n variables

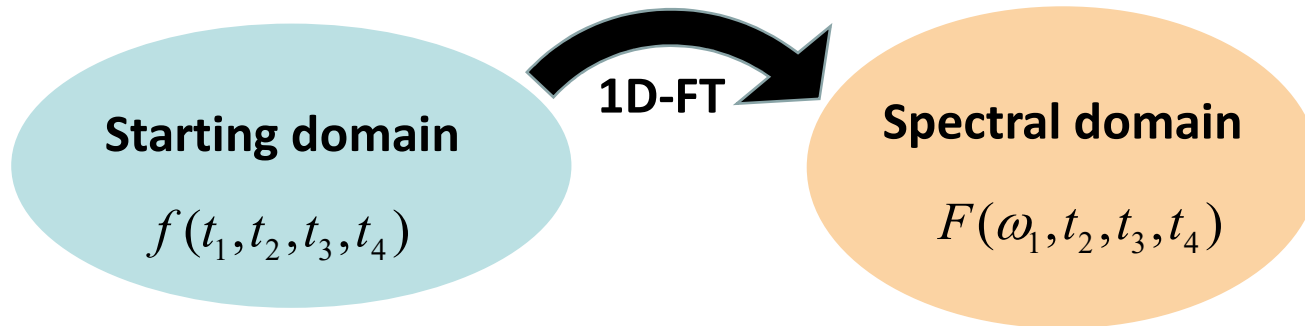

2) Time domain derivative and Fourier Transform

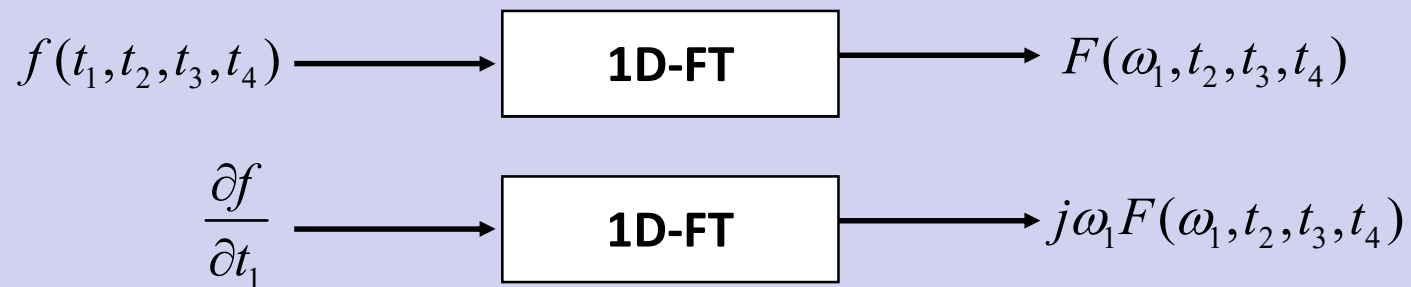

Fourier Transform and functions of n variables

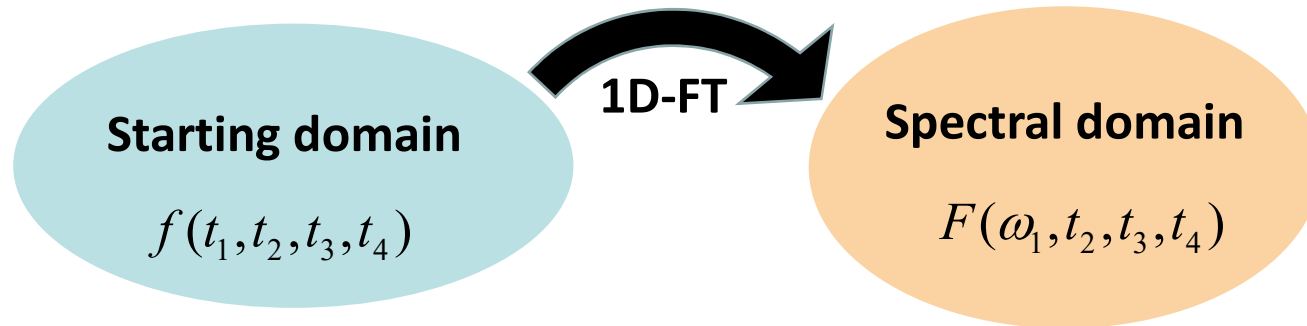

2) Time domain derivative and Fourier Transform

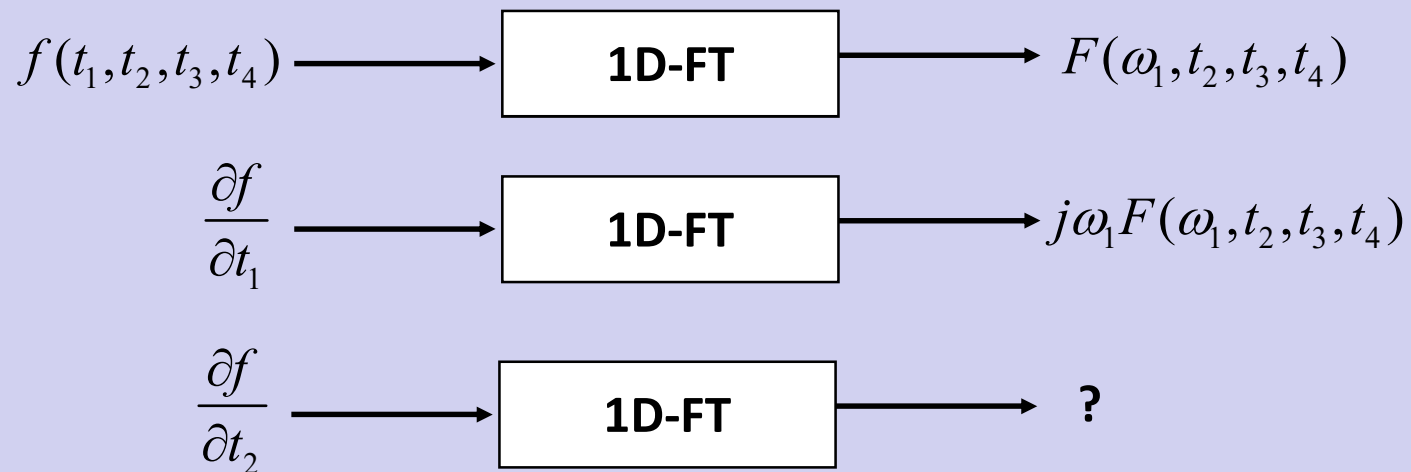

Fourier Transform and functions of n variables

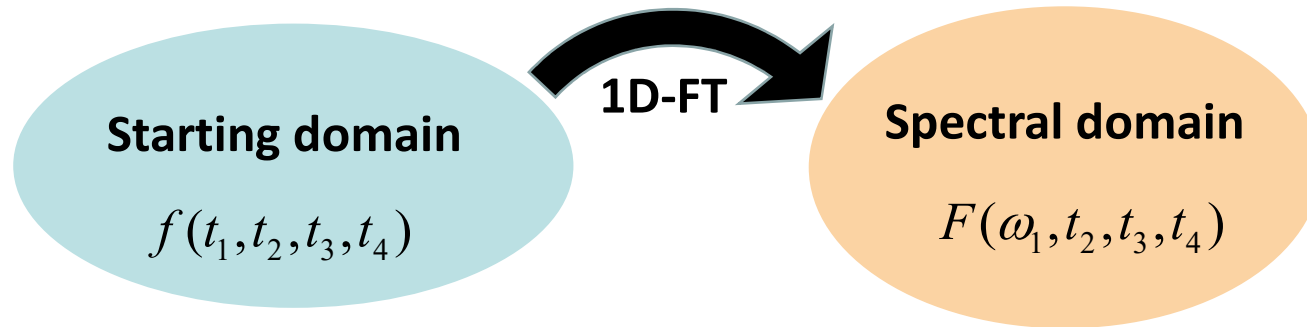

2) Time domain derivative and Fourier Transform

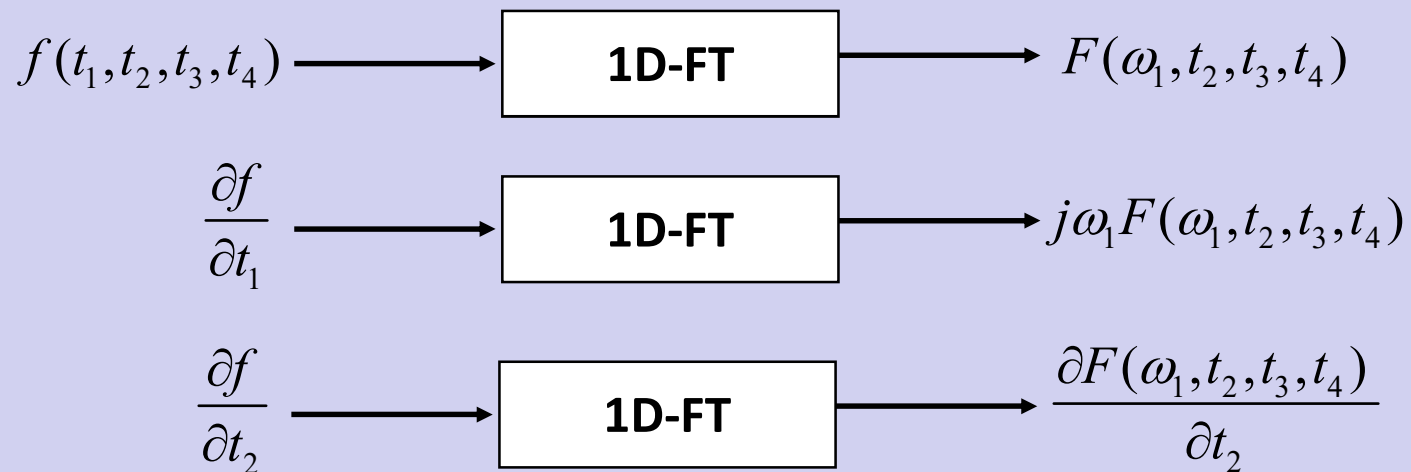

Fourier Transform and functions of n variables

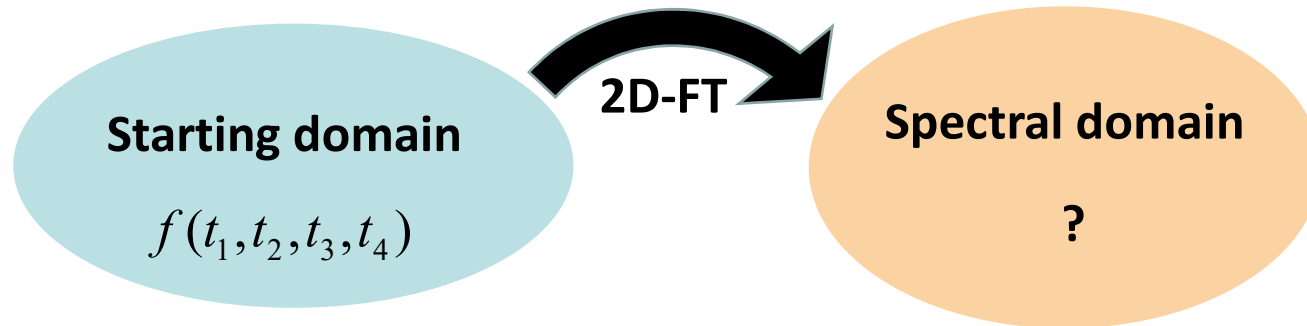

Two Dimensional Fourier Transform (2D-FT)

Fourier Transform and functions of n variables

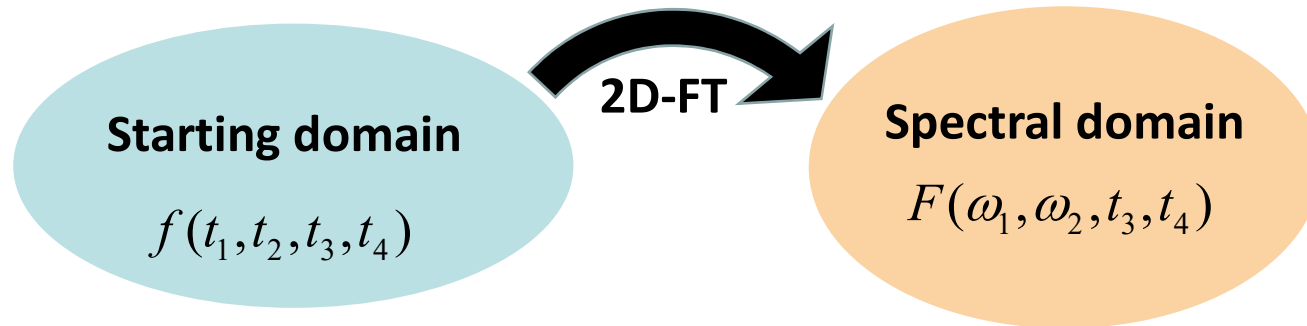

Two Dimensional Fourier Transform (2D-FT)

$$F(\omega_1, \omega_2, t_3, t_4) = \int_{-\infty}^{+\infty} \int_{-\infty}^{+\infty} dt_1 dt_2 f(t_1, t_2, t_3, t_4) e^{-j\omega_1 t_1} e^{-j\omega_2 t_2}$$

Fourier Transform and functions of n variables

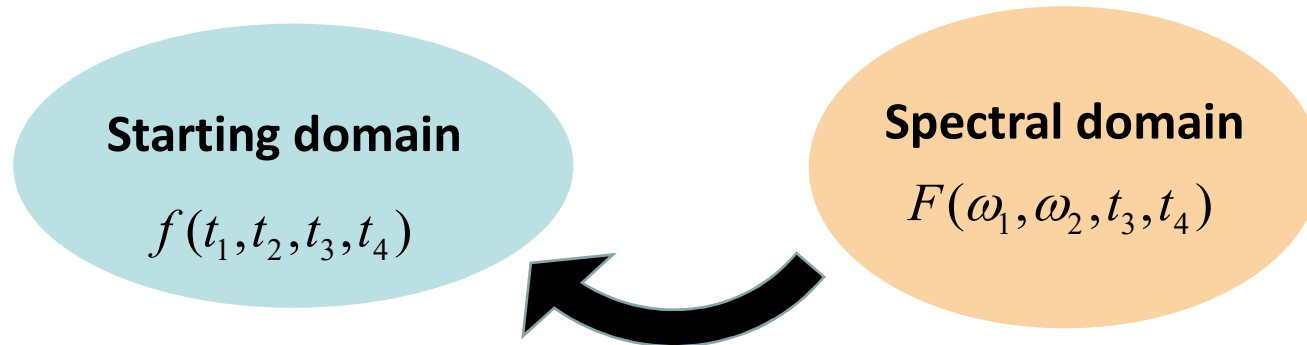

Two Dimensional Fourier Transform (2D-FT)

$$F(\omega_1, \omega_2, t_3, t_4) = \int_{-\infty}^{+\infty} \int_{-\infty}^{+\infty} dt_1 dt_2 f(t_1, t_2, t_3, t_4) e^{-j\omega_1 t_1} e^{-j\omega_2 t_2}$$

1) How to jump back from the Spectral domain to the Time domain

Fourier Transform and functions of n variables

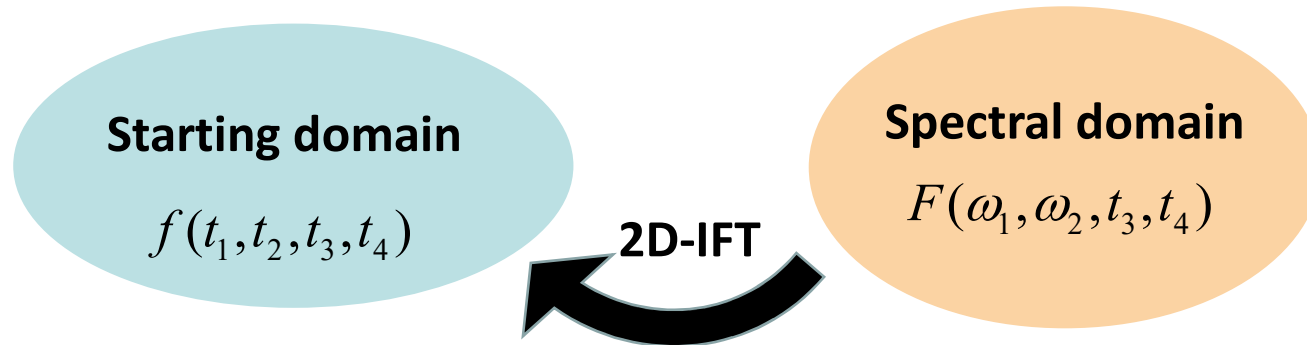

Two Dimensional Fourier Transform (2D-FT)

$$F(\omega_1, \omega_2, t_3, t_4) = \int_{-\infty}^{+\infty} \int_{-\infty}^{+\infty} dt_1 dt_2 f(t_1, t_2, t_3, t_4) e^{-j\omega_1 t_1} e^{-j\omega_2 t_2}$$

1) How to jump back from the Spectral domain to the Time domain

$$f(t_1, t_2, t_3, t_4) = \left(\frac{1}{2\pi}\right)^2 \int_{-\infty}^{+\infty} \int_{-\infty}^{+\infty} F(\omega_1, \omega_2, t_3, t_4) e^{j\omega_1 t_1} e^{j\omega_2 t_2} d\omega_1 d\omega_2 \quad \text{2D-IFT}$$

Fourier Transform and functions of n variables

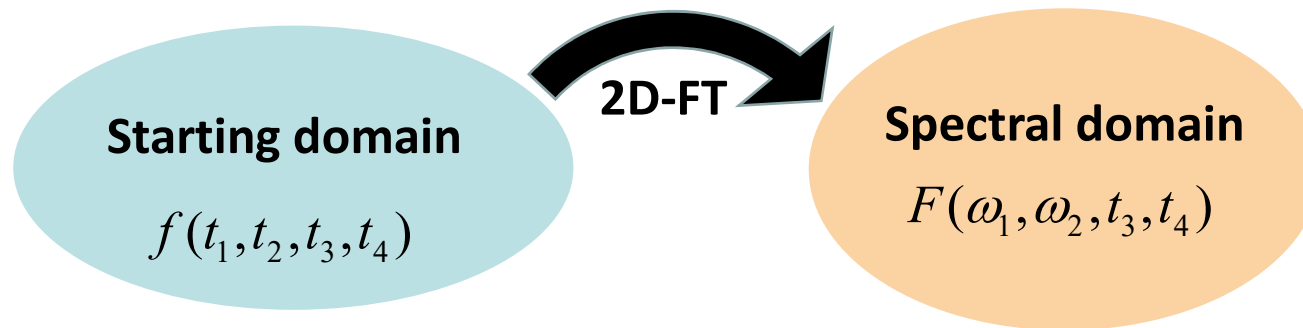

2) Time domain derivative and Fourier Transform

Fourier Transform and functions of n variables

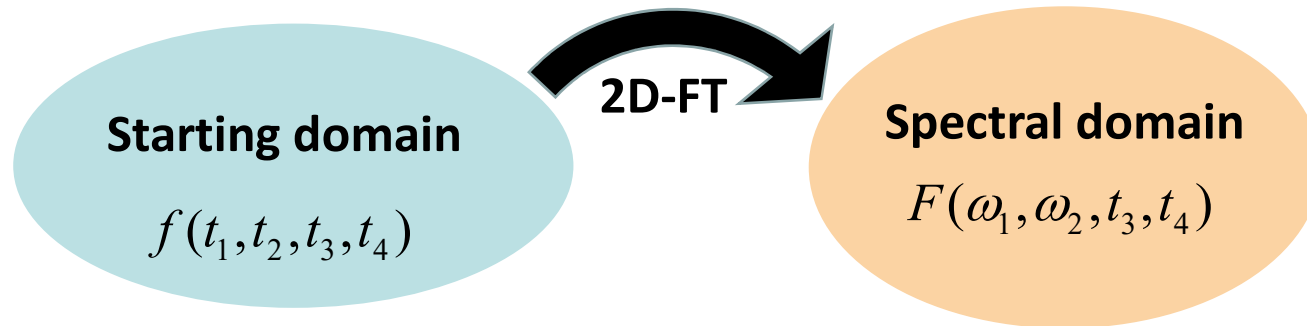

2) Time domain derivative and Fourier Transform

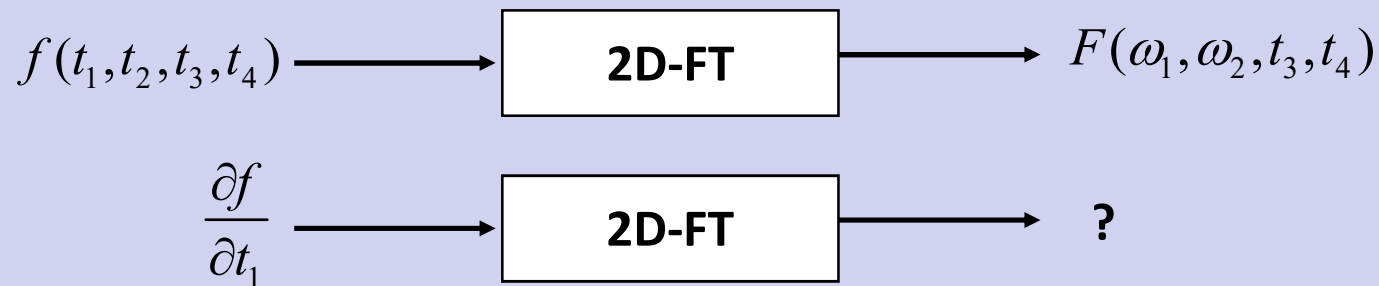

Fourier Transform and functions of n variables

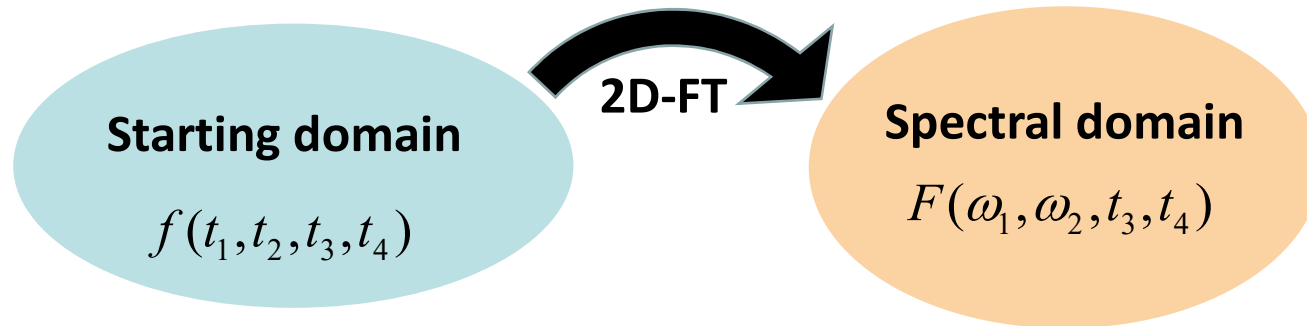

2) Time domain derivative and Fourier Transform

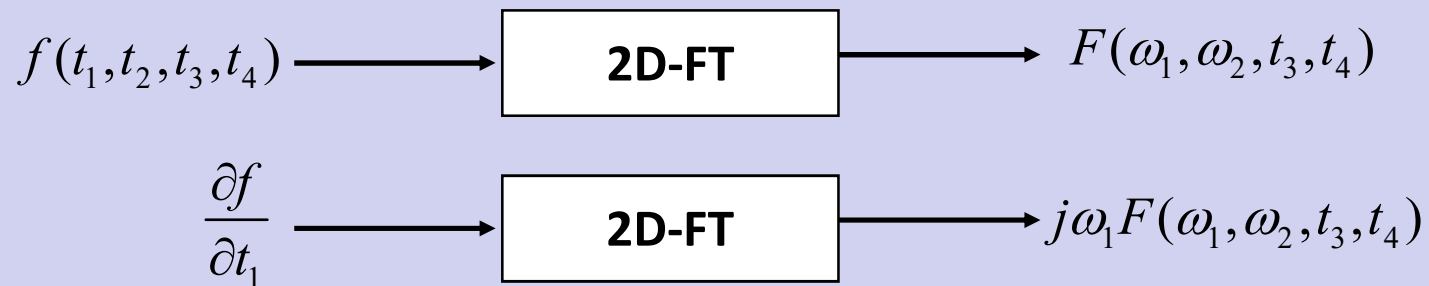

Fourier Transform and functions of n variables

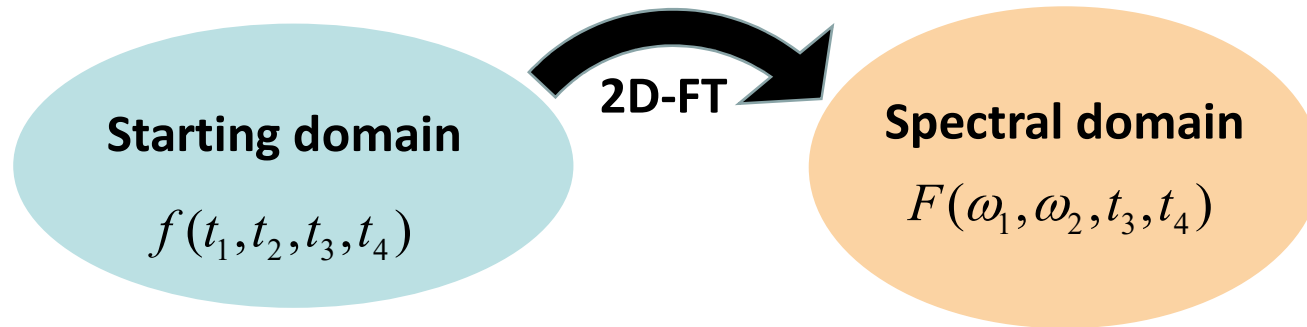

2) Time domain derivative and Fourier Transform

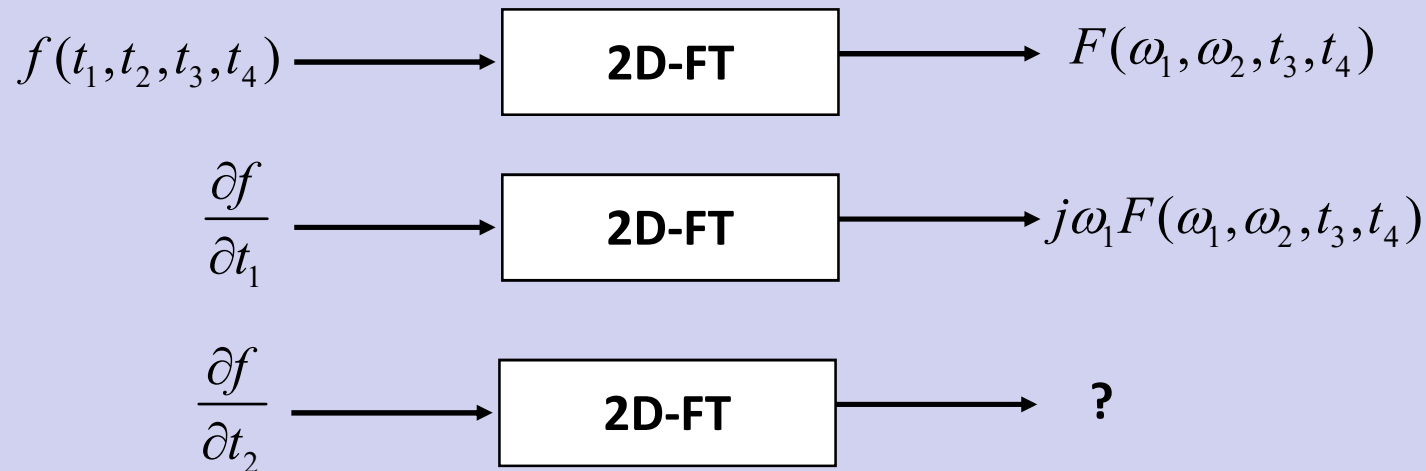

Fourier Transform and functions of n variables

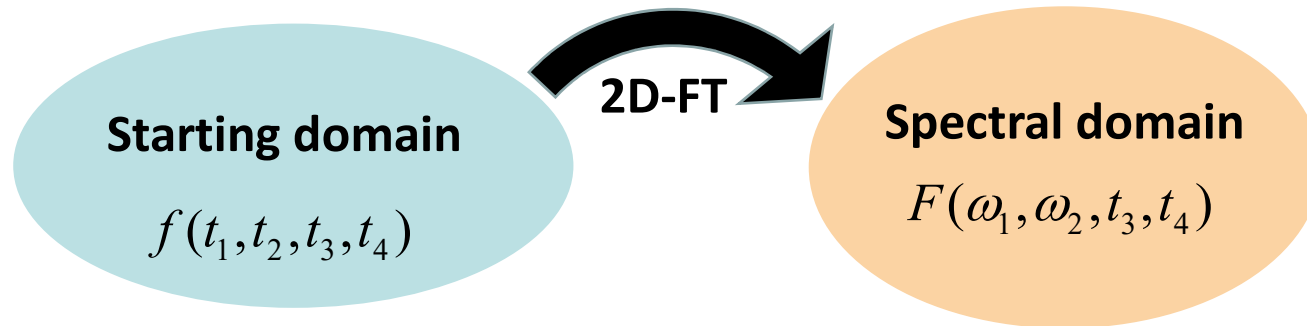

2) Time domain derivative and Fourier Transform

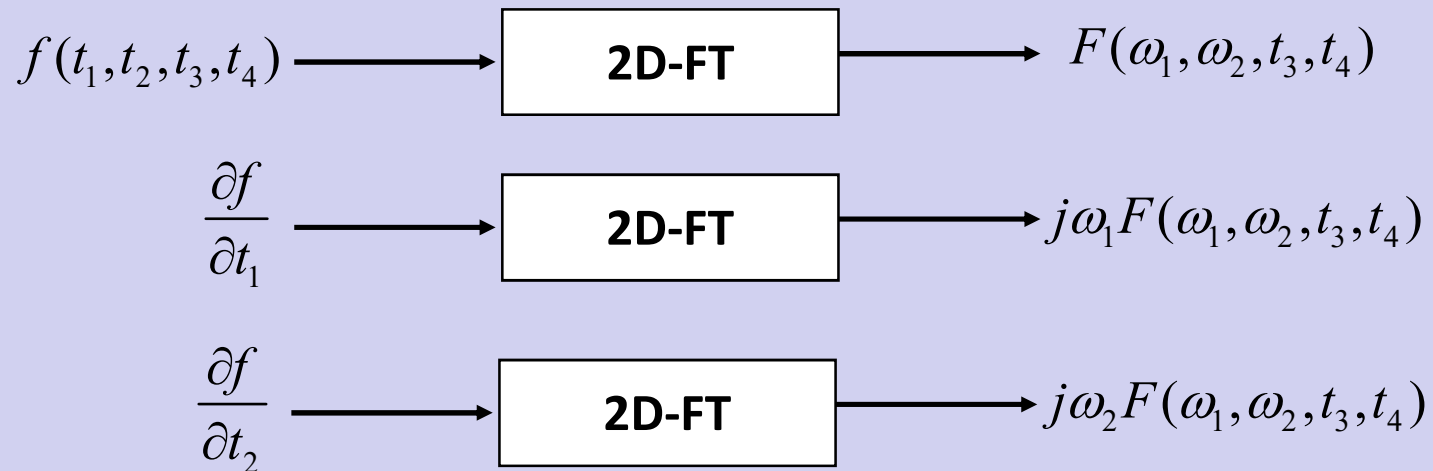

Fourier Transform and functions of n variables

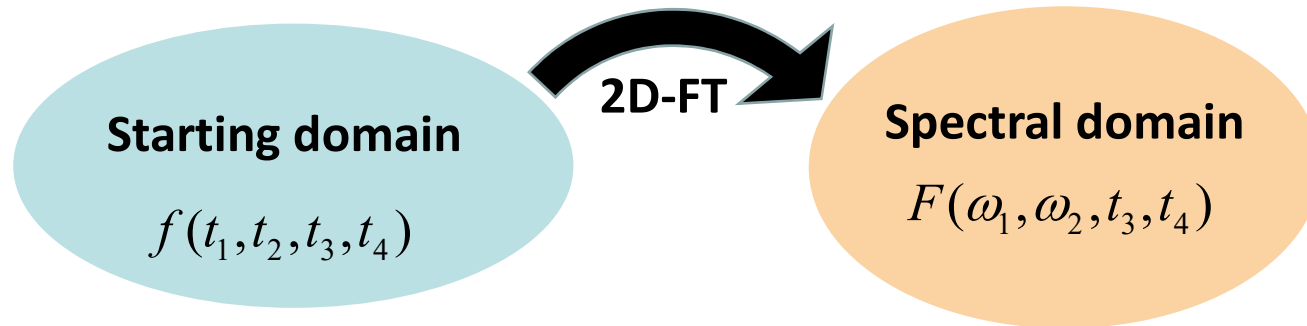

2) Time domain derivative and Fourier Transform

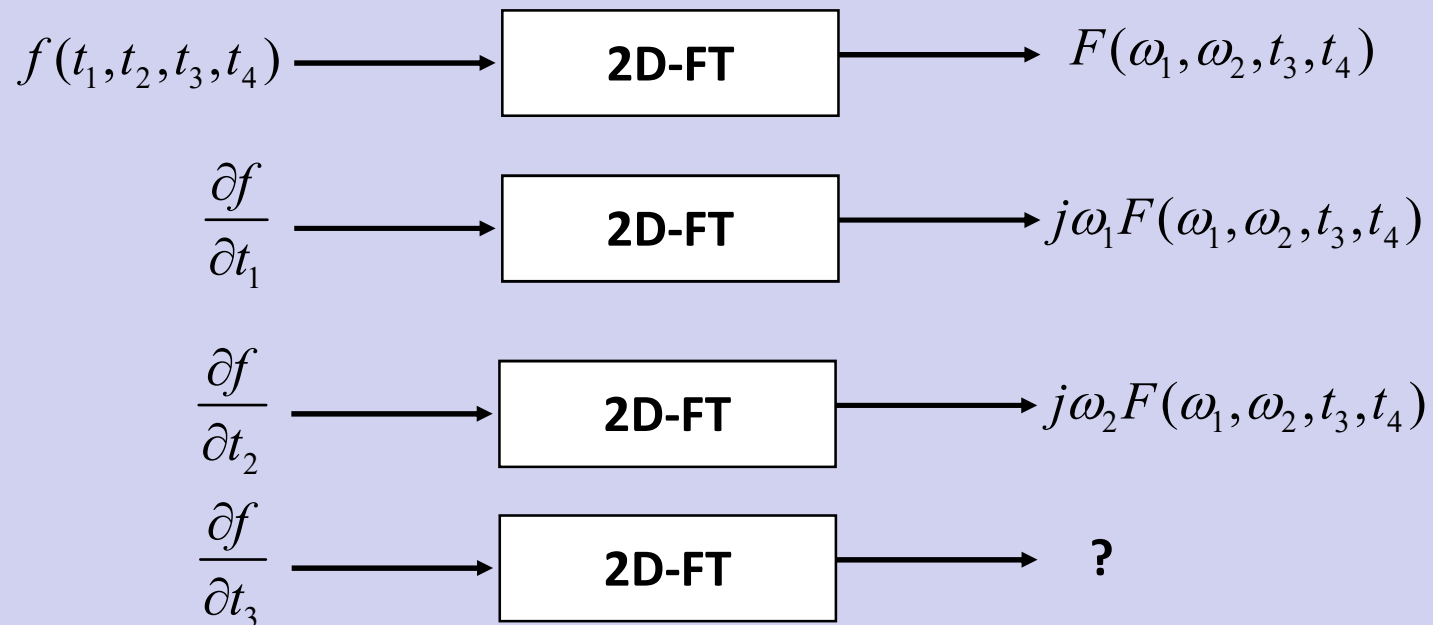

Fourier Transform and functions of n variables

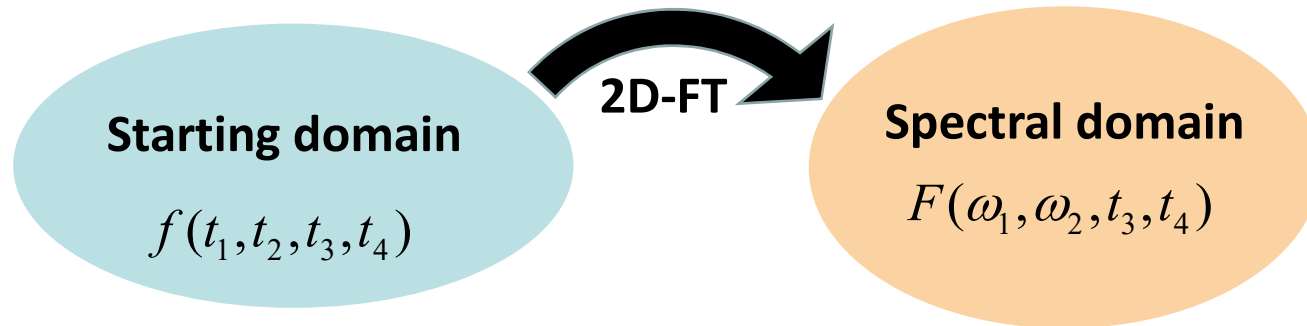

2) Time domain derivative and Fourier Transform

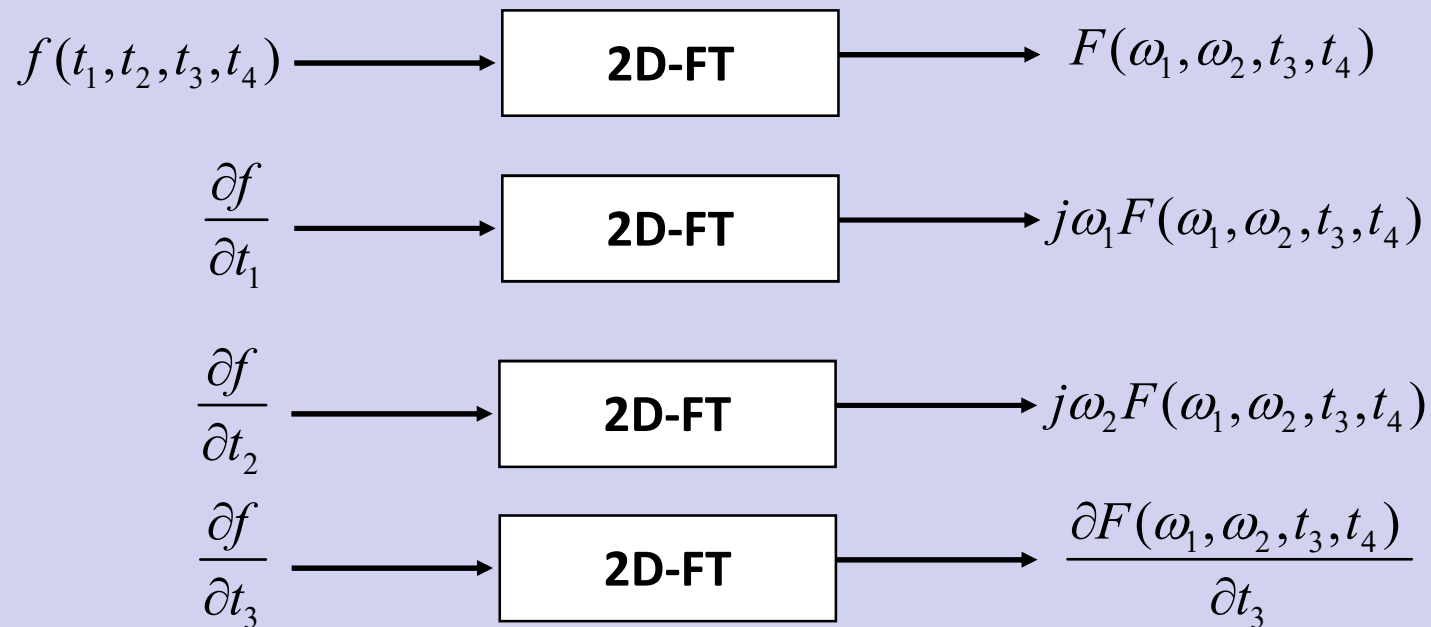

Fourier Transform and functions of n variables

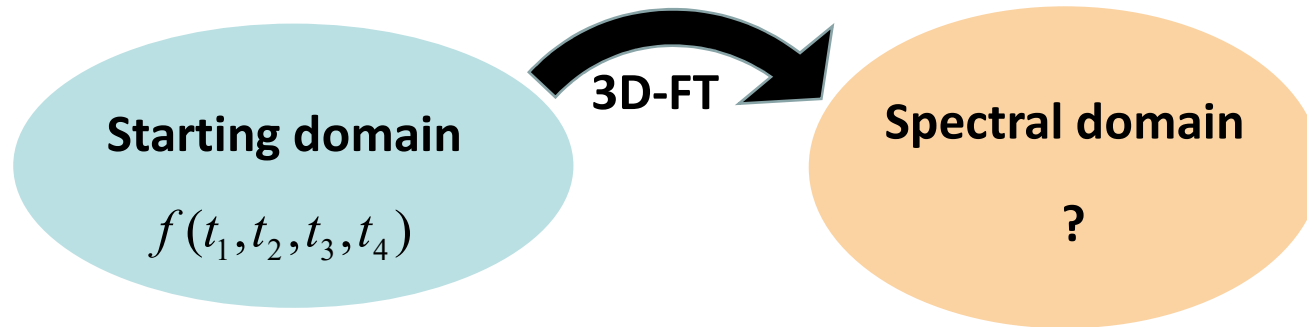

Three Dimensional Fourier Transform (3D-FT)

Fourier Transform and functions of n variables

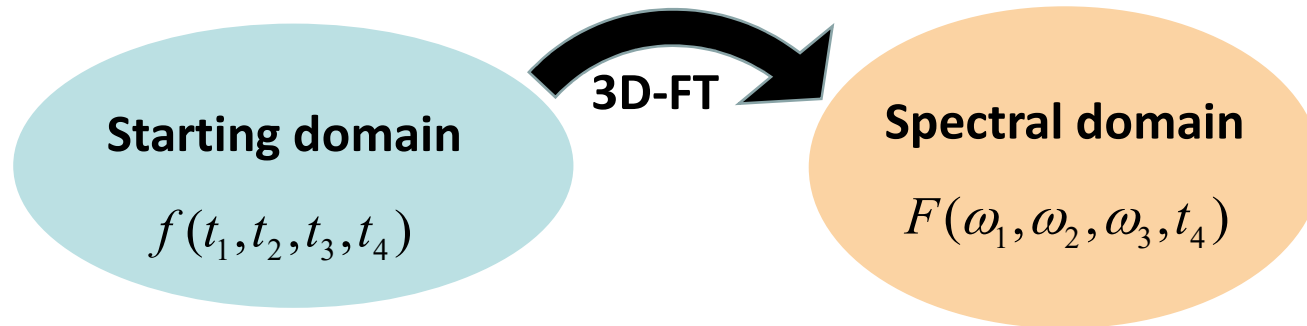

Three Dimensional Fourier Transform (3D-FT)

$$F(\omega_1, \omega_2, \omega_3, t_4) = \int_{-\infty}^{+\infty} \int_{-\infty}^{+\infty} \int_{-\infty}^{+\infty} dt_1 dt_2 dt_3 f(t_1, t_2, t_3, t_4) e^{-j\omega_1 t_1} e^{-j\omega_2 t_2} e^{-j\omega_3 t_3}$$

Fourier Transform and functions of n variables

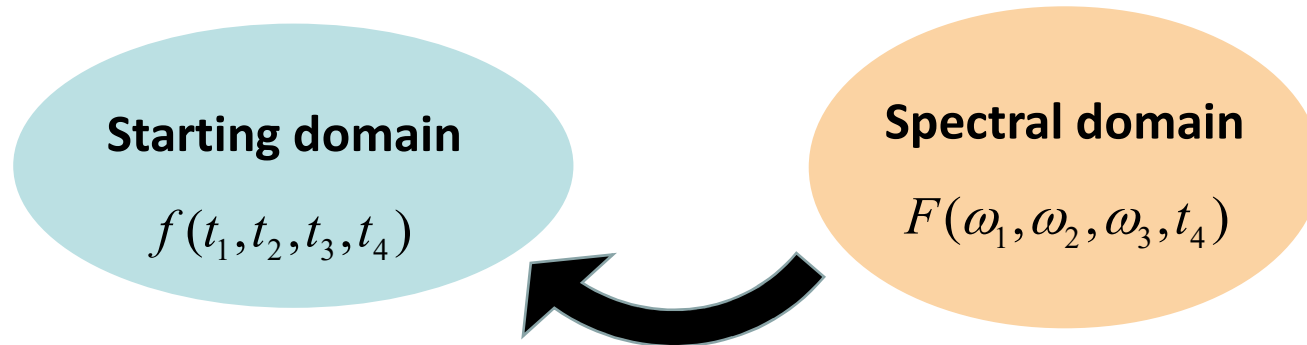

Three Dimensional Fourier Transform (3D-FT)

$$F(\omega_1, \omega_2, \omega_3, t_4) = \int_{-\infty}^{+\infty} \int_{-\infty}^{+\infty} \int_{-\infty}^{+\infty} dt_1 dt_2 dt_3 f(t_1, t_2, t_3, t_4) e^{-j\omega_1 t_1} e^{-j\omega_2 t_2} e^{-j\omega_3 t_3}$$

1) How to jump back from the Spectral domain to the Time domain

Fourier Transform and functions of n variables

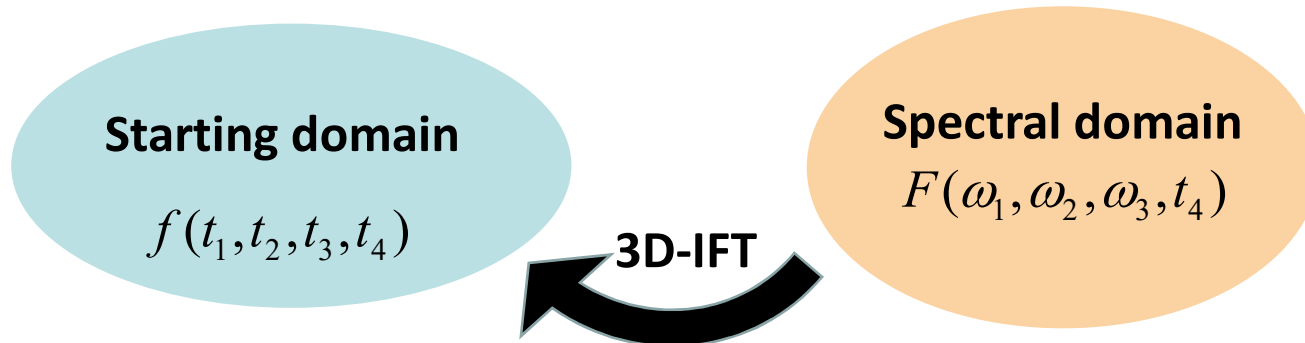

Three Dimensional Fourier Transform (3D-FT)

$$F(\omega_1, \omega_2, \omega_3, t_4) = \int_{-\infty}^{+\infty} \int_{-\infty}^{+\infty} \int_{-\infty}^{+\infty} dt_1 dt_2 dt_3 f(t_1, t_2, t_3, t_4) e^{-j\omega_1 t_1} e^{-j\omega_2 t_2} e^{-j\omega_3 t_3}$$

1) How to jump back from the Spectral domain to the Time domain

$$f(t_1, t_2, t_3, t_4) = \left(\frac{1}{2\pi}\right)^3 \int_{-\infty}^{+\infty} \int_{-\infty}^{+\infty} \int_{-\infty}^{+\infty} F(\omega_1, \omega_2, \omega_3, t_4) e^{j\omega_1 t_1} e^{j\omega_2 t_2} e^{j\omega_3 t_3} d\omega_1 d\omega_2 d\omega_3 \quad \text{3D-IFT}$$

Fourier Transform and functions of n variables

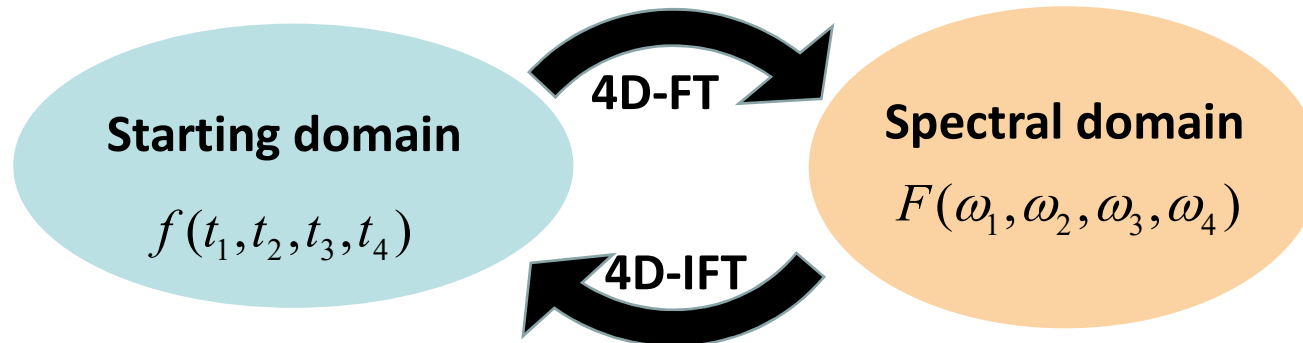

Four Dimensional Fourier Transform (4D-FT)

$$F(\omega_1, \omega_2, \omega_3, \omega_4) = \int_{-\infty}^{+\infty} \int_{-\infty}^{+\infty} \int_{-\infty}^{+\infty} \int_{-\infty}^{+\infty} dt_1 dt_2 dt_3 dt_4 f(t_1, t_2, t_3, t_4) e^{-j\omega_1 t_1} e^{-j\omega_2 t_2} e^{-j\omega_3 t_3} e^{-j\omega_4 t_4}$$

1) How to jump back from the Spectral domain to the Time domain

$$f(t_1, t_2, t_3, t_4) = \left(\frac{1}{2\pi}\right)^4 \int_{-\infty}^{+\infty} \int_{-\infty}^{+\infty} \int_{-\infty}^{+\infty} \int_{-\infty}^{+\infty} F(\omega_1, \omega_2, \omega_3, \omega_4) e^{j\omega_1 t_1} e^{j\omega_2 t_2} e^{j\omega_3 t_3} e^{j\omega_4 t_4} d\omega_1 d\omega_2 d\omega_3 d\omega_4 \quad \text{4D-IFT}$$

Fourier Transform and functions of n variables

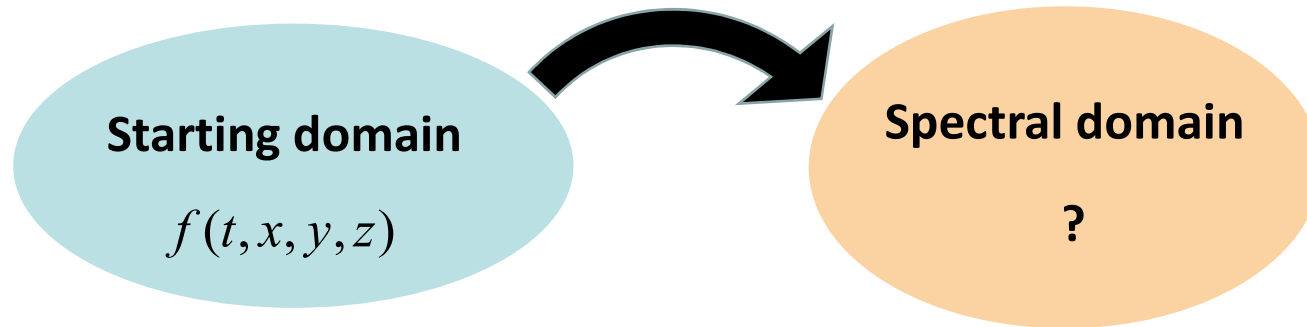

Fourier Transform and functions of n variables

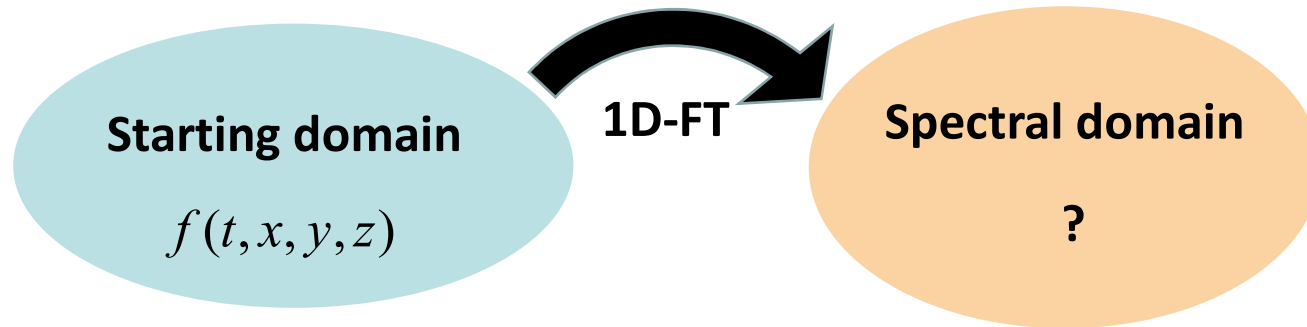

One Dimensional Fourier Transform (1D-FT)

Fourier Transform and functions of n variables

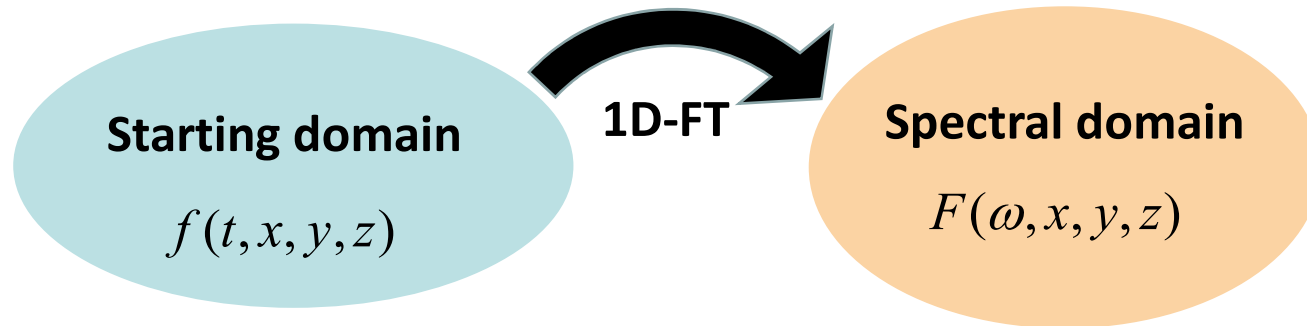

One Dimensional Fourier Transform (1D-FT)

$$F(\omega, x, y, z) = \int_{-\infty}^{+\infty} f(t, x, y, z) e^{-j\omega t} dt$$

Fourier Transform and functions of n variables

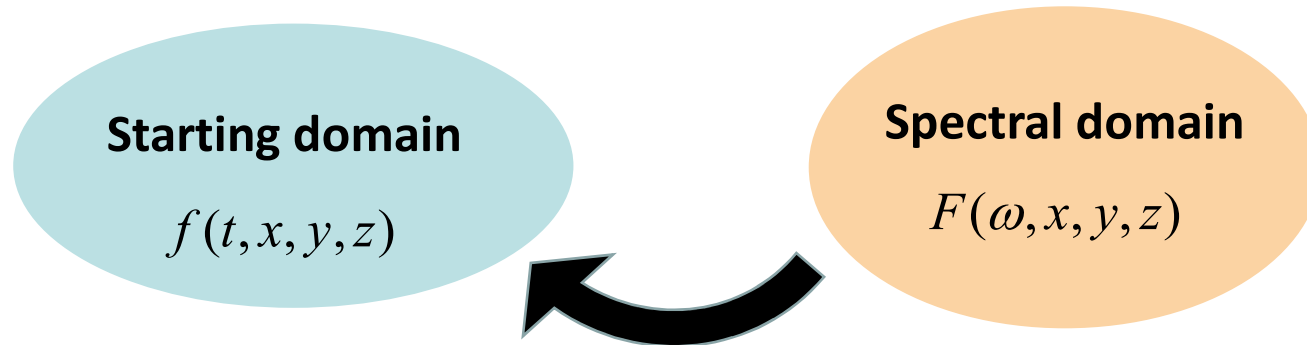

One Dimensional Fourier Transform (1D-FT)

$$F(\omega, x, y, z) = \int_{-\infty}^{+\infty} f(t, x, y, z) e^{-j\omega t} dt$$

1) How to jump back from the Spectral domain to the Time domain

Fourier Transform and functions of n variables

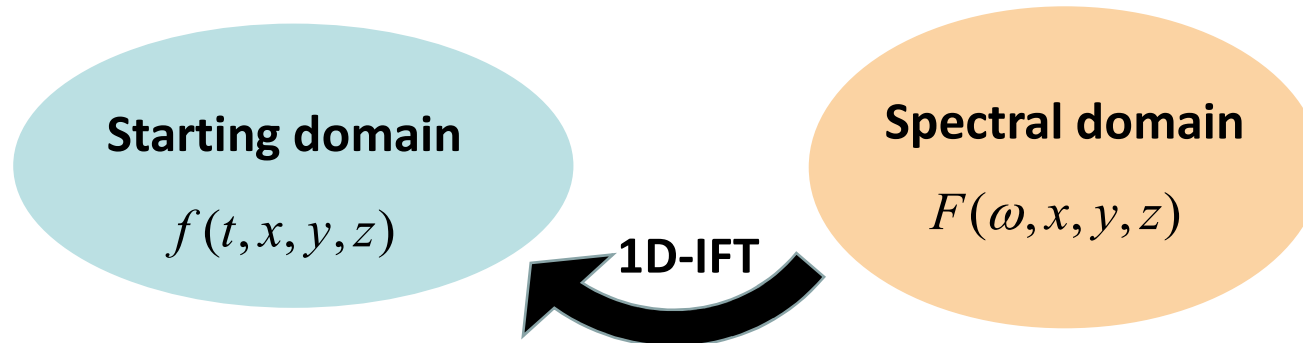

One Dimensional Fourier Transform (1D-FT)

$$F(\omega, x, y, z) = \int_{-\infty}^{+\infty} f(t, x, y, z) e^{-j\omega t} dt$$

1) How to jump back from the Spectral domain to the Time domain

$$f(t, x, y, z) = \frac{1}{2\pi} \int_{-\infty}^{+\infty} F(\omega, x, y, z) e^{j\omega t} d\omega \quad \text{1D-IFT}$$

Fourier Transform and functions of n variables

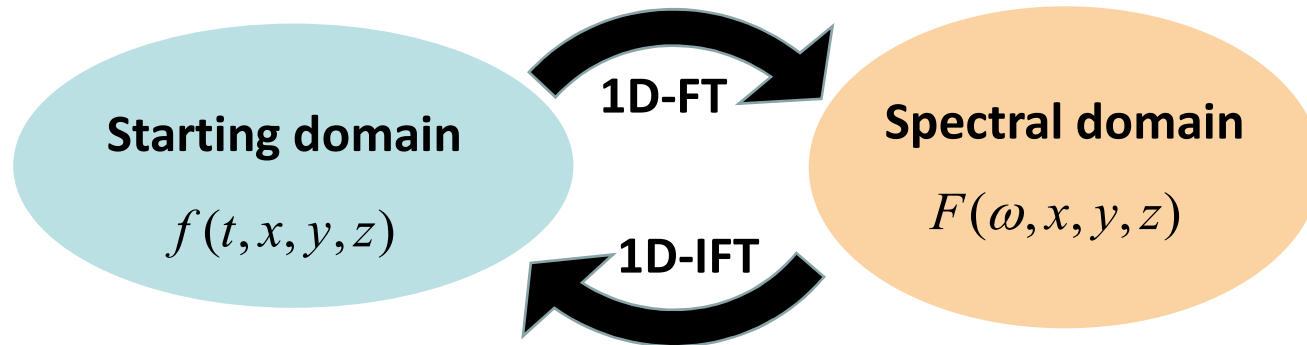

$$f(t, x, y, z) \xrightarrow{\text{1D-FT}} F(\omega, x, y, z) = \int_{-\infty}^{+\infty} f(t, x, y, z) e^{-j\omega t} dt$$

$$F(\omega, x, y, z) \xrightarrow{\text{1D-IFT}} f(t, x, y, z) = \frac{1}{2\pi} \int_{-\infty}^{+\infty} F(\omega, x, y, z) e^{j\omega t} d\omega$$

Fourier Transform and functions of n variables

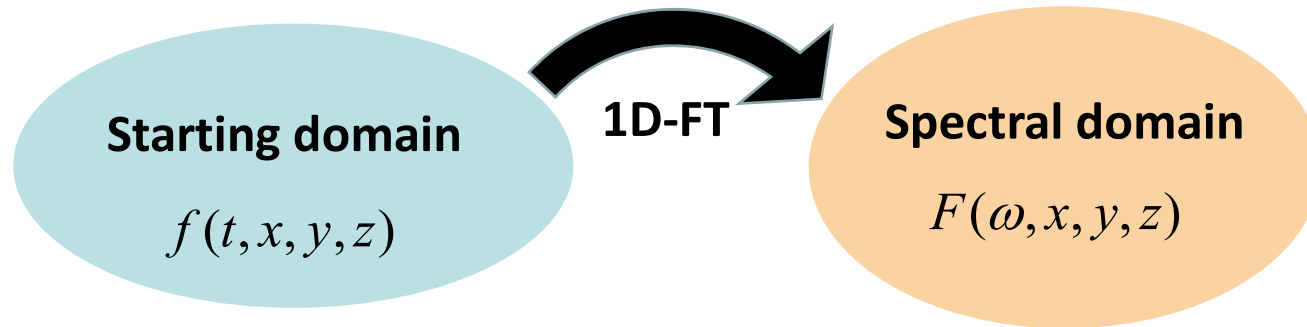

2) Time domain derivative and Fourier Transform

Fourier Transform and functions of n variables

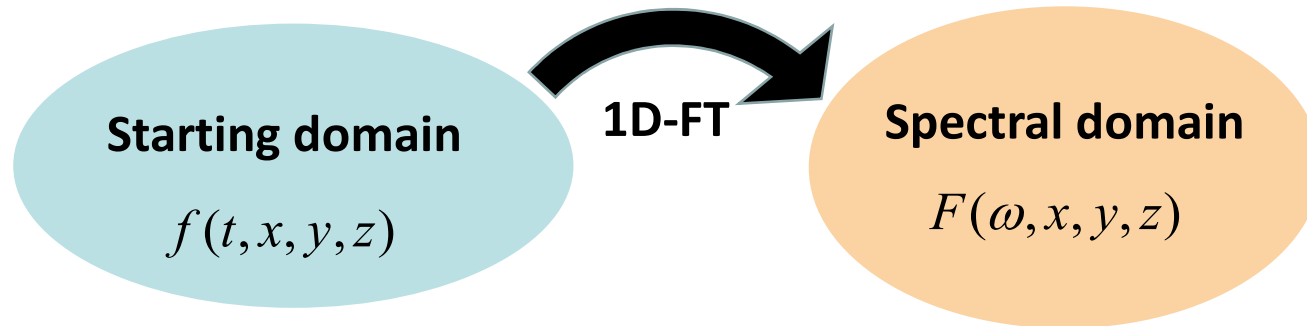

2) Time domain derivative and Fourier Transform

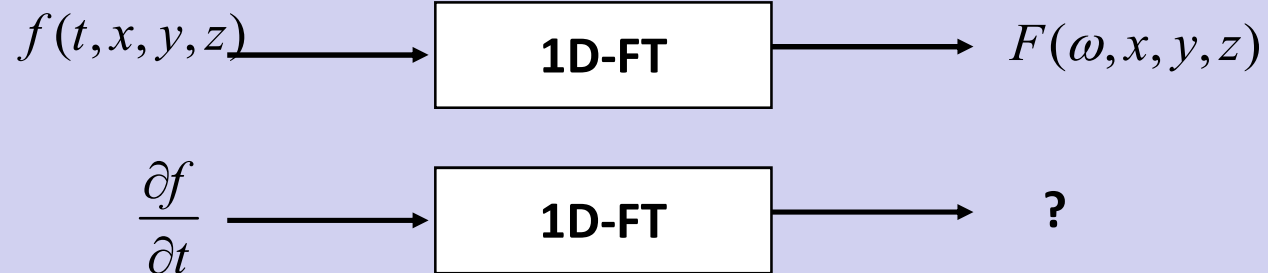

Fourier Transform and functions of n variables

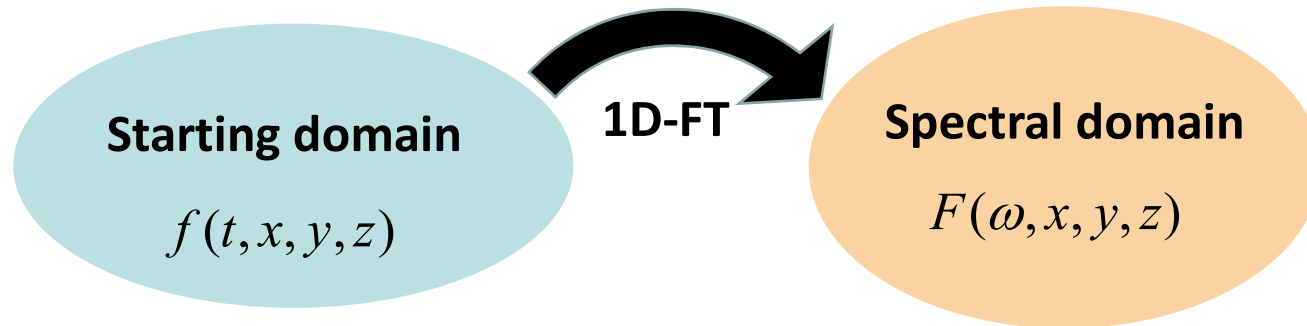

2) Time domain derivative and Fourier Transform

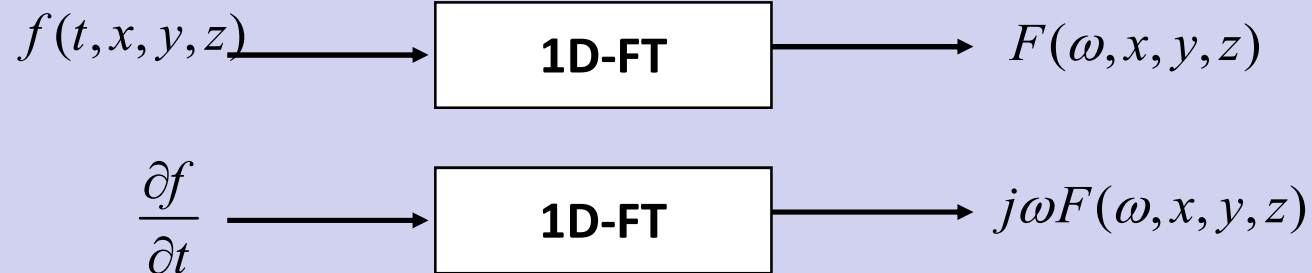

Fourier Transform and functions of n variables

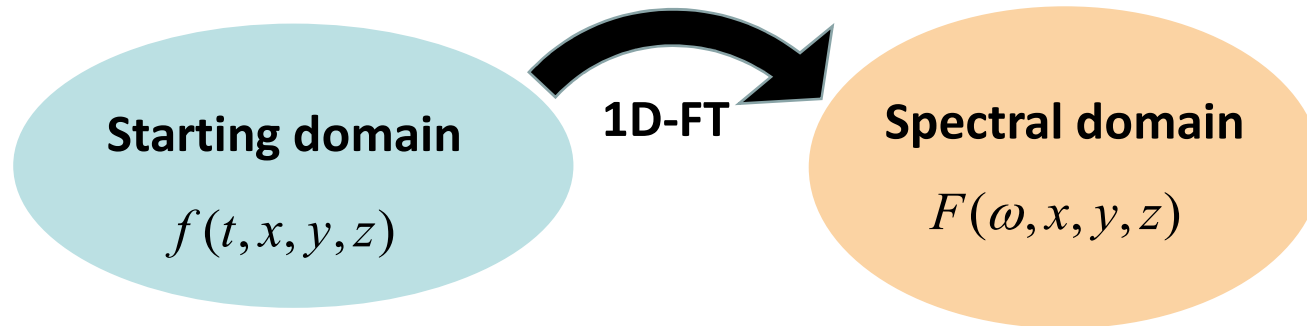

2) Time domain derivative and Fourier Transform

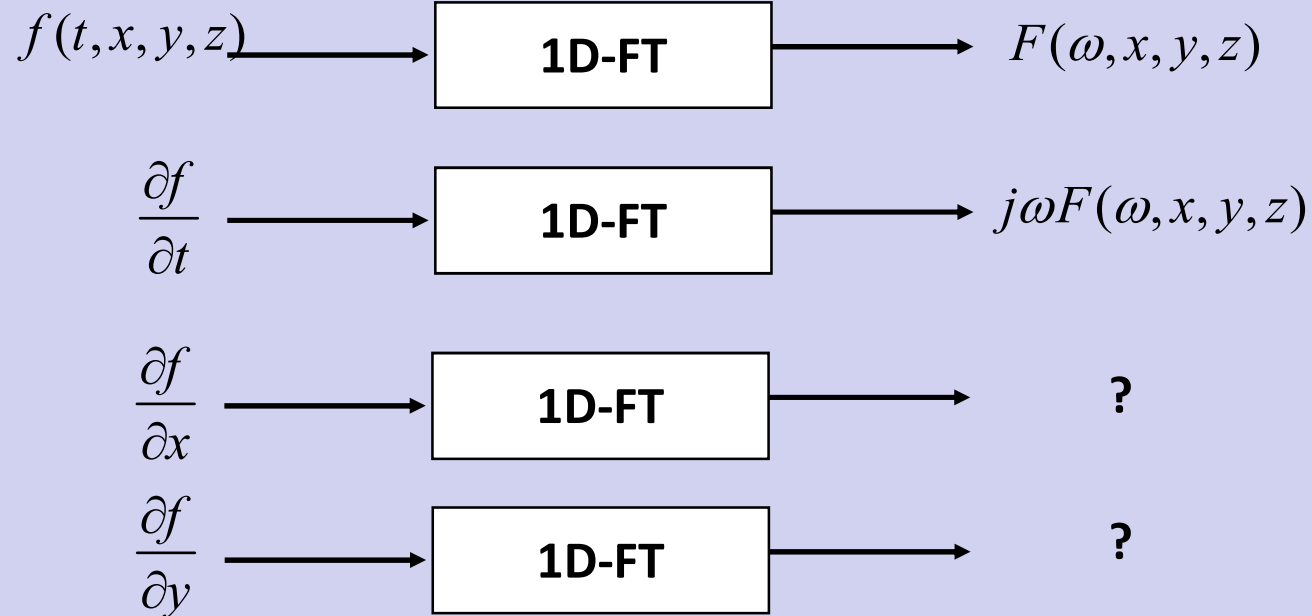

Fourier Transform and functions of n variables

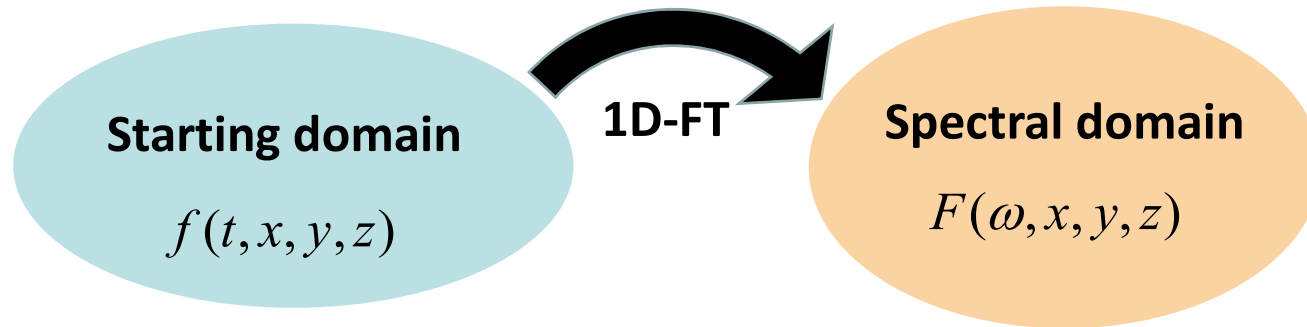

2) Time domain derivative and Fourier Transform

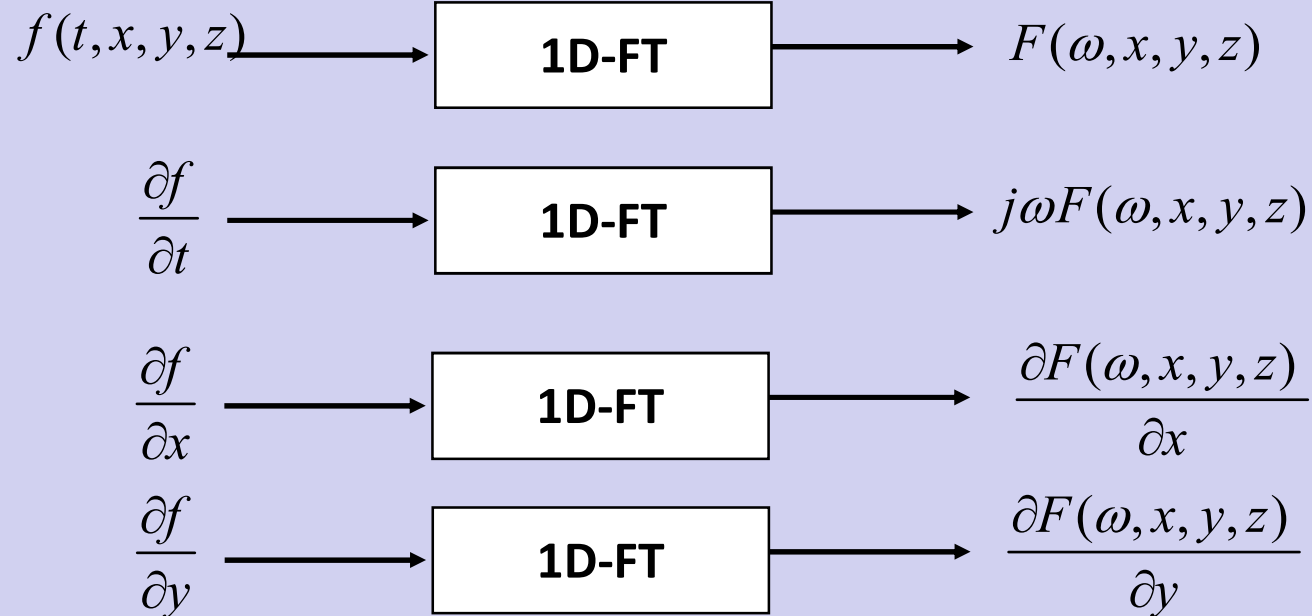

Fourier Transform and functions of n variables

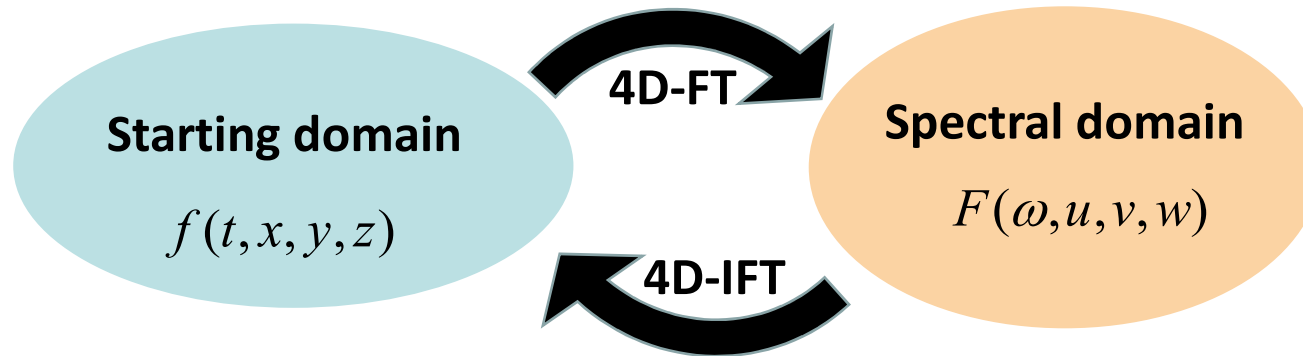

Four Dimensional Fourier Transform (4D-FT)

$$F(\omega, u, v, w) = \int_{-\infty}^{+\infty} \int_{-\infty}^{+\infty} \int_{-\infty}^{+\infty} \int_{-\infty}^{+\infty} f(t, x, y, z) e^{-j\omega t} e^{-jux} e^{-jvy} e^{-jwz} dt dx dy dz$$

1) How to jump back from the Spectral domain to the Time domain

$$f(t, x, y, z) = \left(\frac{1}{2\pi}\right)^4 \int_{-\infty}^{+\infty} \int_{-\infty}^{+\infty} \int_{-\infty}^{+\infty} \int_{-\infty}^{+\infty} F(\omega, u, v, w) e^{j\omega t} e^{jux} e^{jvy} e^{jwz} d\omega du dv dw \quad \text{4D-IFT}$$

Frequency domain

- Fourier Transform and functions of n variables
- **Fourier Transform and vector functions**
- Fourier Transform and vector functions of n variables

- 1) How to jump back from the Frequency domain to the Time domain**
- 2) Time domain derivative and Fourier Transform**

Fourier Transform and vector functions

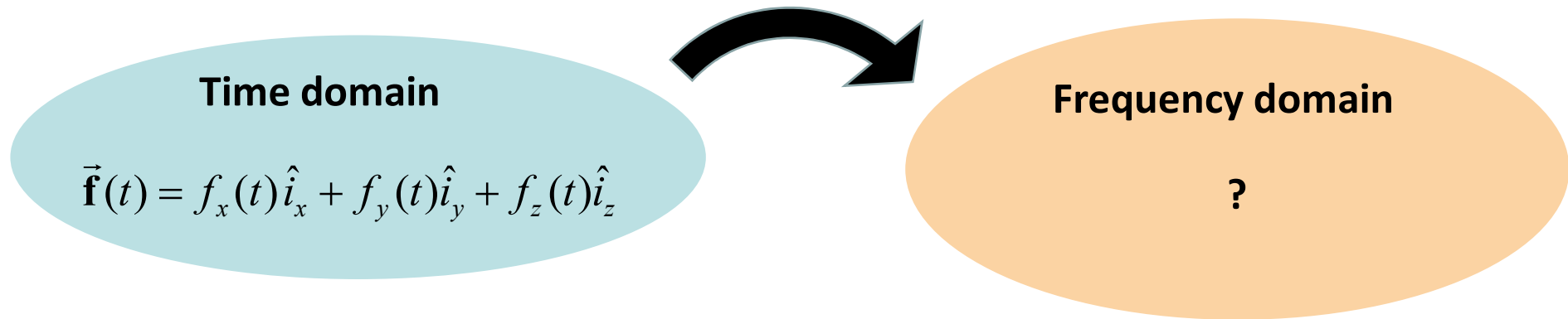

Fourier Transform and vector functions

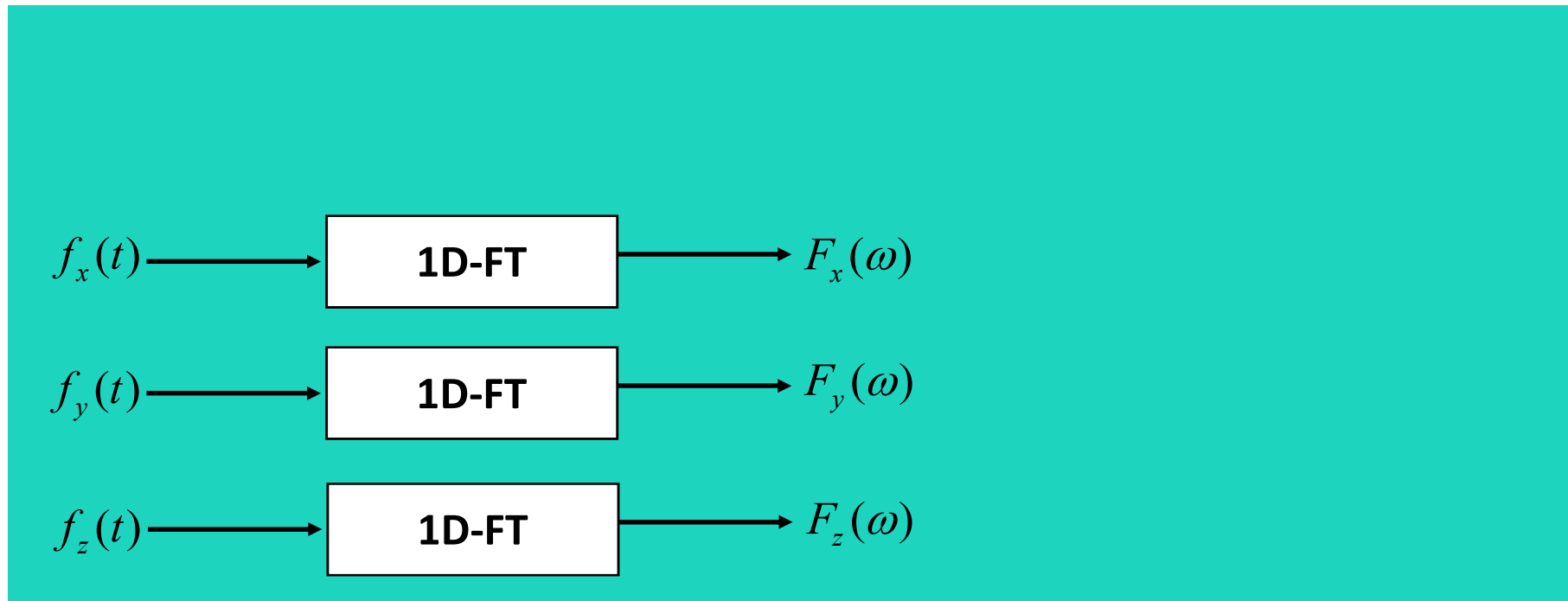
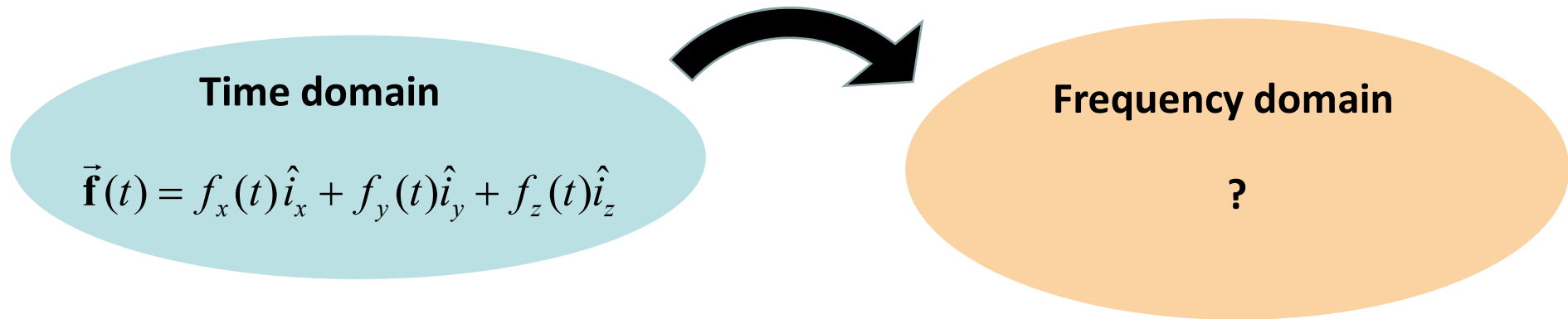

Fourier Transform and vector functions

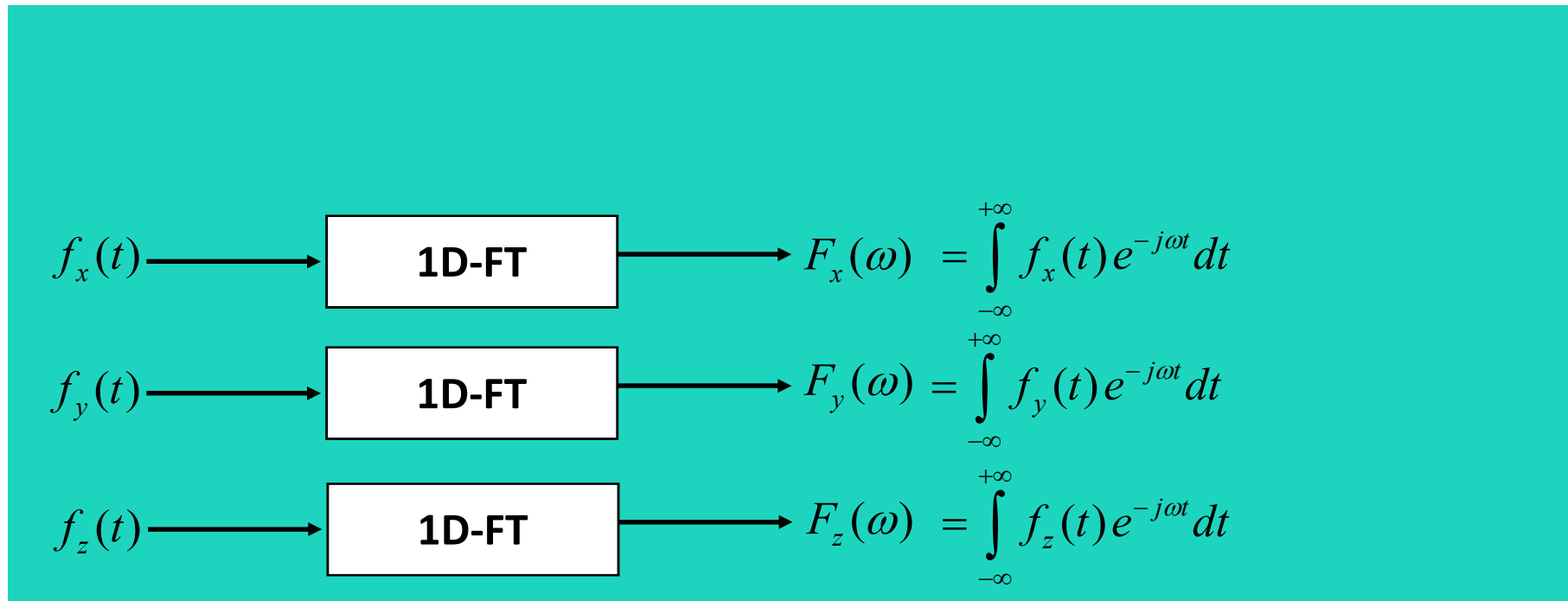
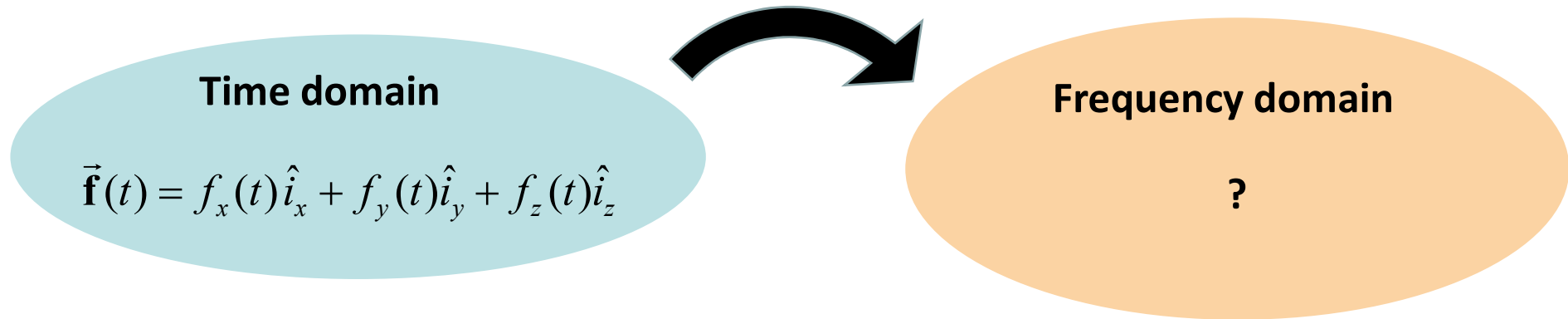

Fourier Transform and vector functions

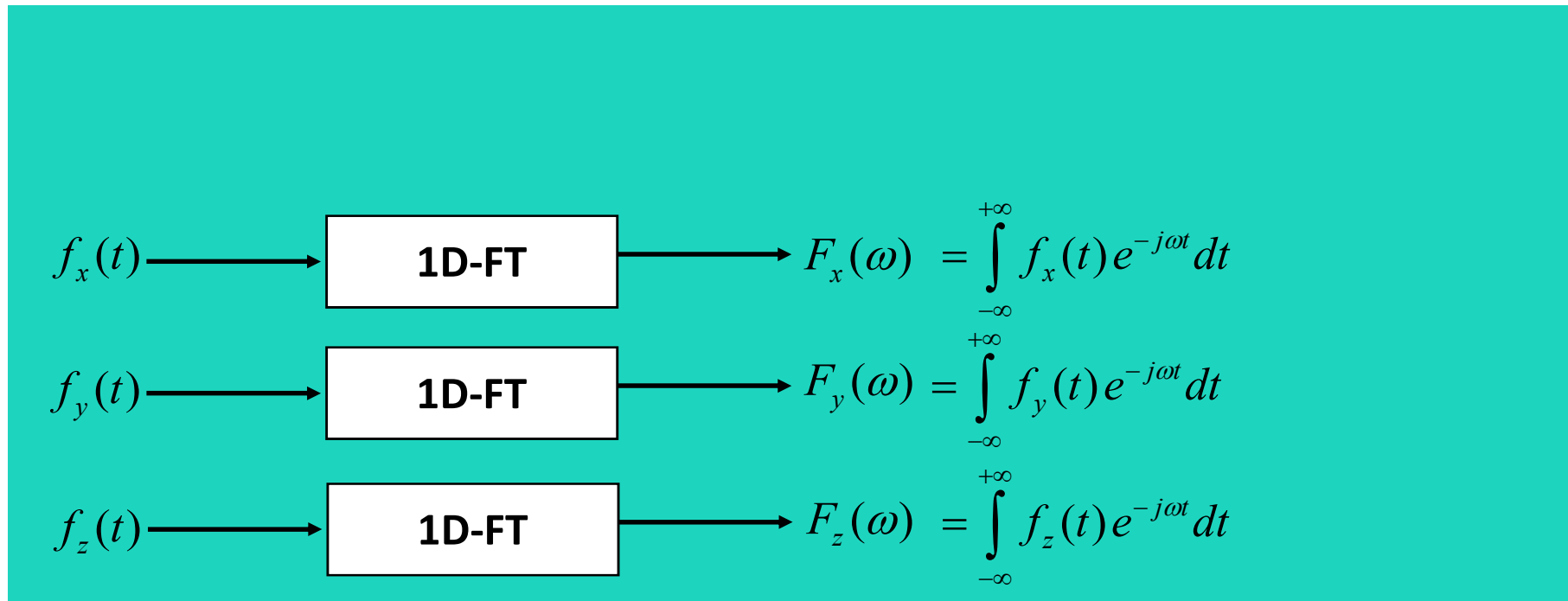
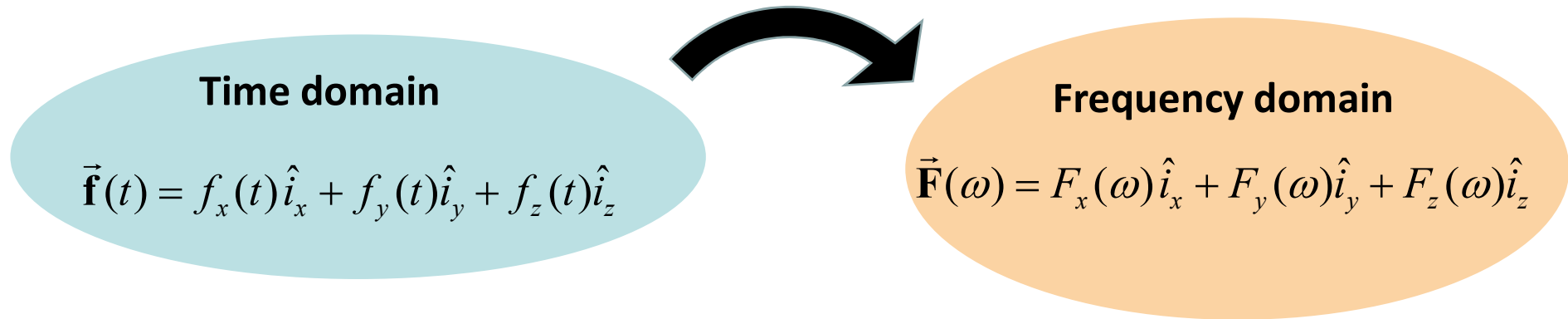

Fourier Transform and vector functions

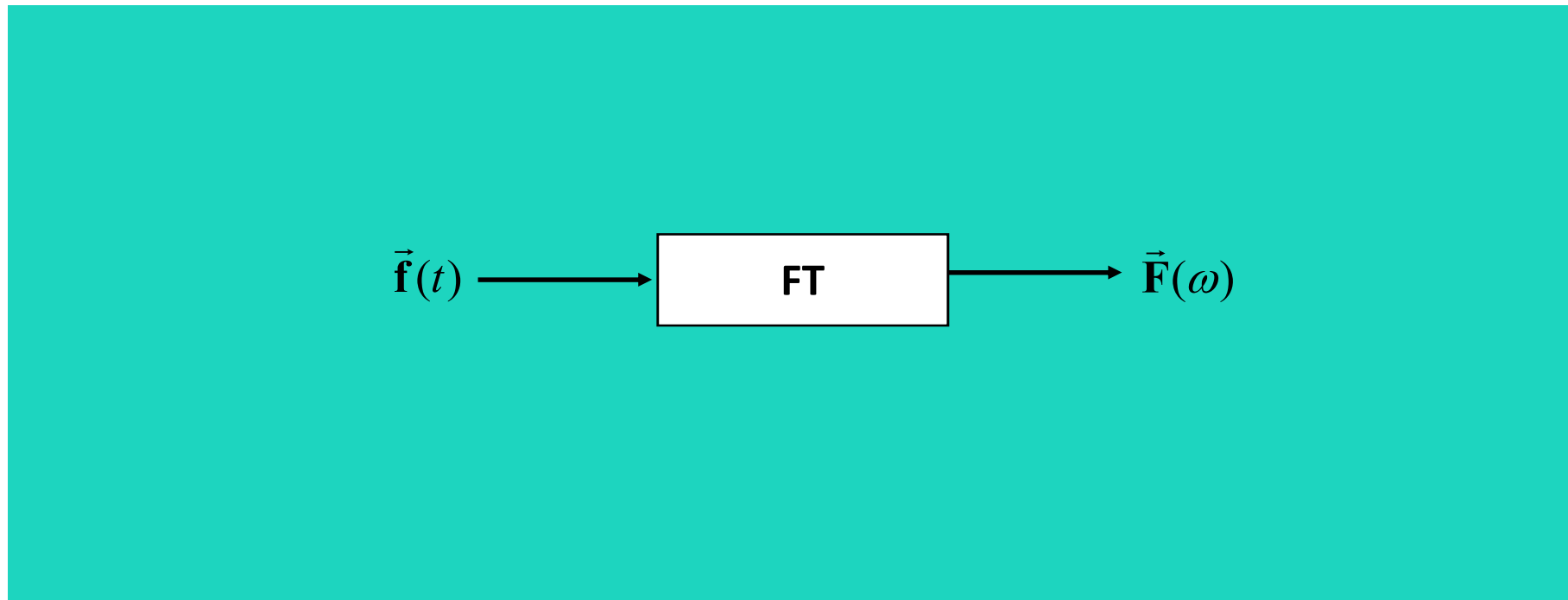
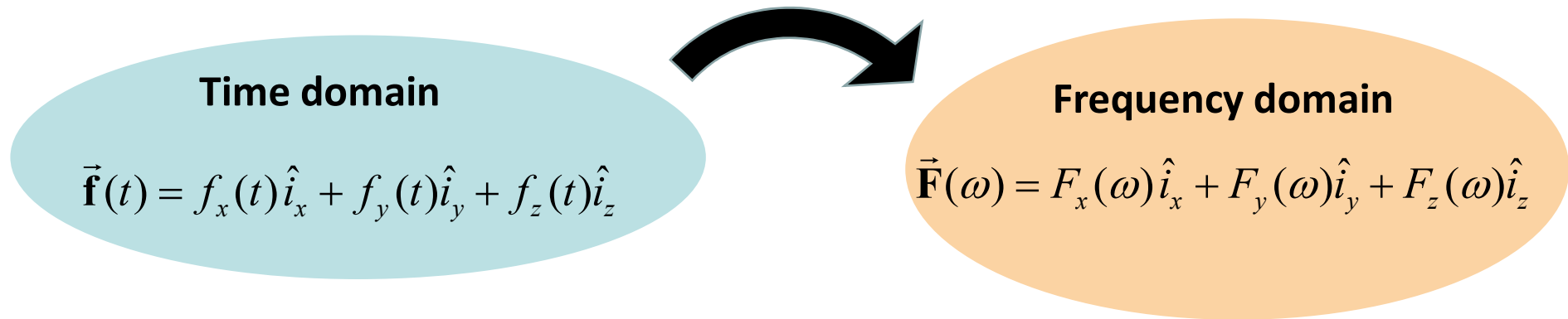

Fourier Transform and vector functions

Time domain

$$\vec{\mathbf{f}}(t) = f_x(t)\hat{i}_x + f_y(t)\hat{i}_y + f_z(t)\hat{i}_z$$

Frequency domain

$$\vec{\mathbf{F}}(\omega) = F_x(\omega)\hat{i}_x + F_y(\omega)\hat{i}_y + F_z(\omega)\hat{i}_z$$



1) How to jump back from the Spectral domain to the Time domain

Fourier Transform and vector functions

Time domain

$$\vec{\mathbf{f}}(t) = f_x(t)\hat{i}_x + f_y(t)\hat{i}_y + f_z(t)\hat{i}_z$$

Frequency domain

$$\vec{\mathbf{F}}(\omega) = F_x(\omega)\hat{i}_x + F_y(\omega)\hat{i}_y + F_z(\omega)\hat{i}_z$$



1) How to jump back from the Spectral domain to the Time domain

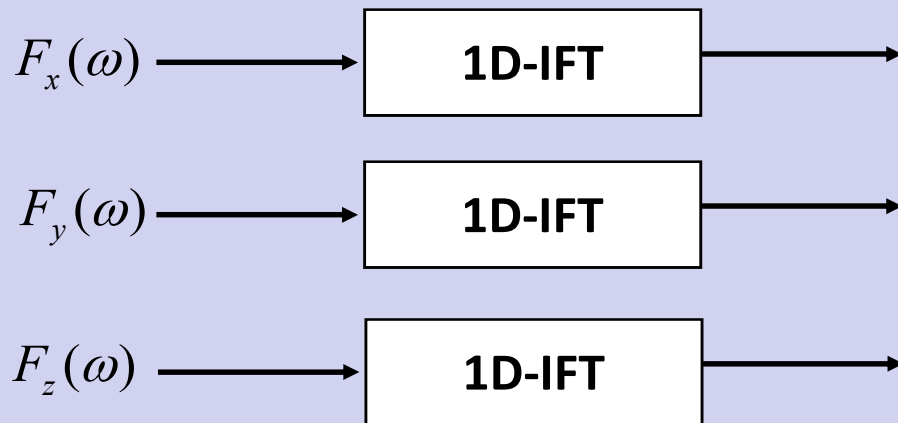

Fourier Transform and vector functions

Time domain

$$\vec{\mathbf{f}}(t) = f_x(t)\hat{i}_x + f_y(t)\hat{i}_y + f_z(t)\hat{i}_z$$

Frequency domain

$$\vec{\mathbf{F}}(\omega) = F_x(\omega)\hat{i}_x + F_y(\omega)\hat{i}_y + F_z(\omega)\hat{i}_z$$



1) How to jump back from the Spectral domain to the Time domain

$$\begin{array}{l} F_x(\omega) \longrightarrow \boxed{\text{1D-IFT}} \longrightarrow f_x(t) = \frac{1}{2\pi} \int_{-\infty}^{+\infty} F_x(\omega) e^{j\omega t} d\omega \\ F_y(\omega) \longrightarrow \boxed{\text{1D-IFT}} \longrightarrow f_y(t) = \frac{1}{2\pi} \int_{-\infty}^{+\infty} F_y(\omega) e^{j\omega t} d\omega \\ F_z(\omega) \longrightarrow \boxed{\text{1D-IFT}} \longrightarrow f_z(t) = \frac{1}{2\pi} \int_{-\infty}^{+\infty} F_z(\omega) e^{j\omega t} d\omega \end{array}$$

Fourier Transform and vector functions

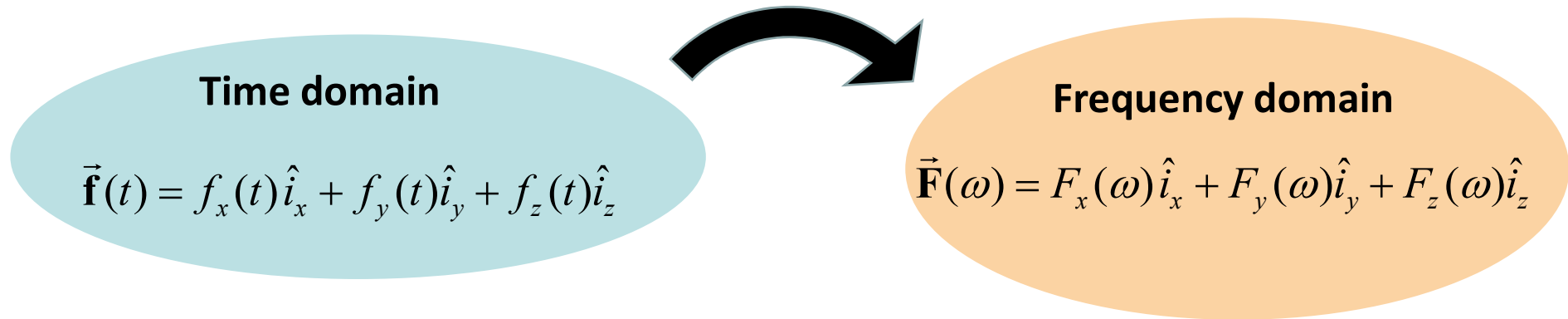

2) Time domain derivative and Fourier Transform

Fourier Transform and vector functions

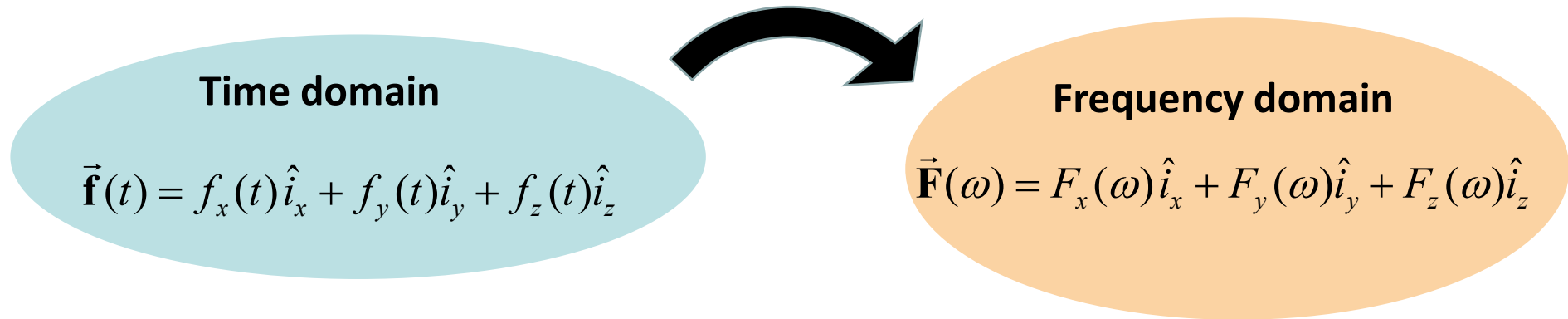

2) Time domain derivative and Fourier Transform

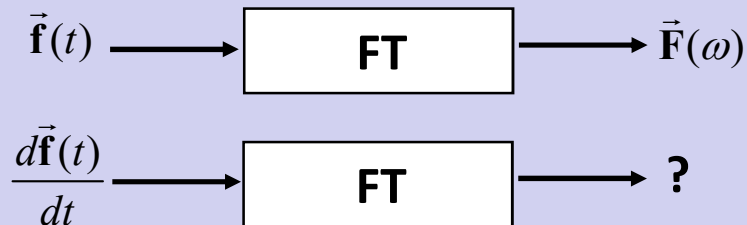

Fourier Transform and vector functions

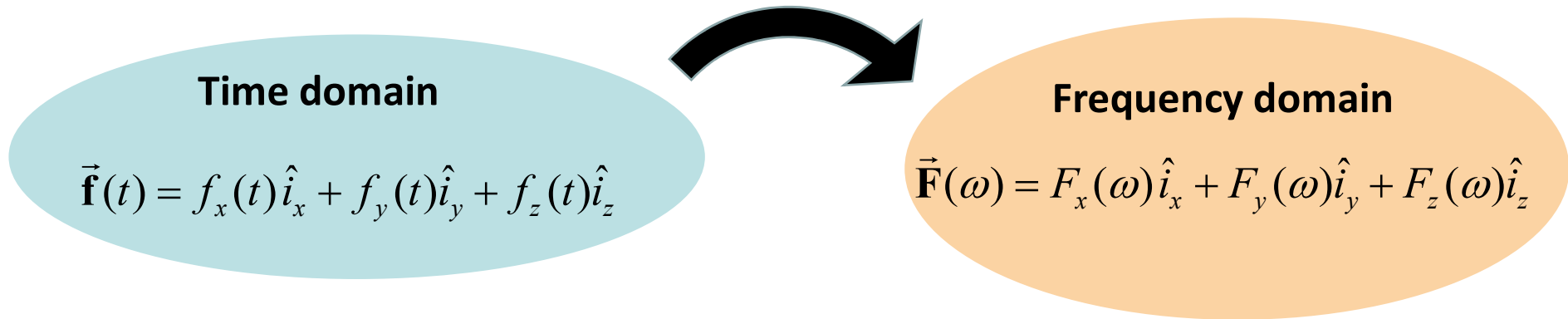

2) Time domain derivative and Fourier Transform

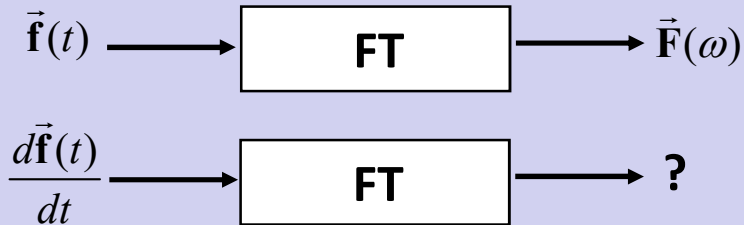

$$\frac{d\vec{\mathbf{f}}(t)}{dt} = \frac{df_x(t)}{dt}\hat{i}_x + \frac{df_y(t)}{dt}\hat{i}_y + \frac{df_z(t)}{dt}\hat{i}_z$$

Fourier Transform and vector functions

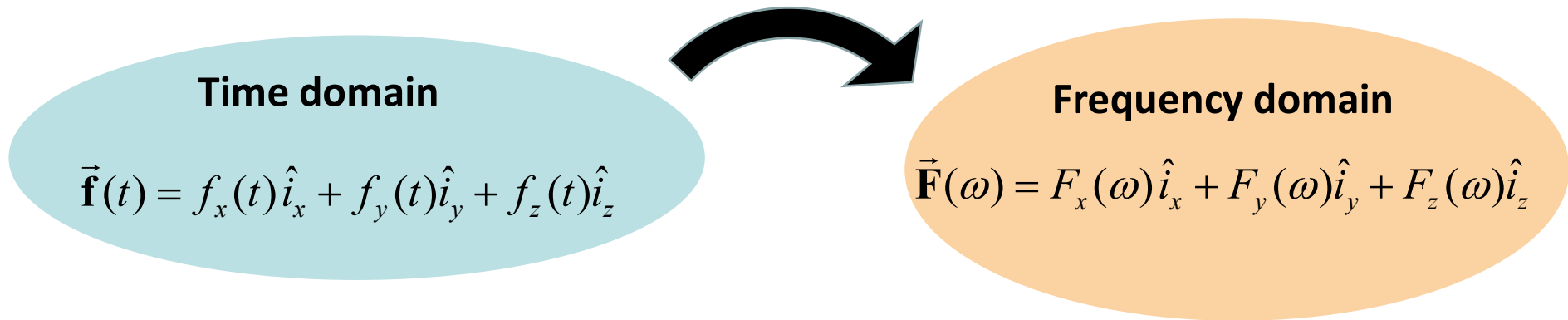

2) Time domain derivative and Fourier Transform

$$\vec{\mathbf{f}}(t) \longrightarrow \boxed{\text{FT}} \longrightarrow \vec{\mathbf{F}}(\omega)$$

$$\frac{d\vec{\mathbf{f}}(t)}{dt} \longrightarrow \boxed{\text{FT}} \longrightarrow ?$$

$$\frac{d\vec{\mathbf{f}}(t)}{dt} = \frac{df_x(t)}{dt}\hat{i}_x + \frac{df_y(t)}{dt}\hat{i}_y + \frac{df_z(t)}{dt}\hat{i}_z$$

$$\frac{df_x(t)}{dt} \longrightarrow \boxed{\text{1D-FT}} \longrightarrow ?$$

$$\frac{df_y(t)}{dt} \longrightarrow \boxed{\text{1D-FT}} \longrightarrow ?$$

$$\frac{df_z(t)}{dt} \longrightarrow \boxed{\text{1D-FT}} \longrightarrow ?$$

Fourier Transform and vector functions

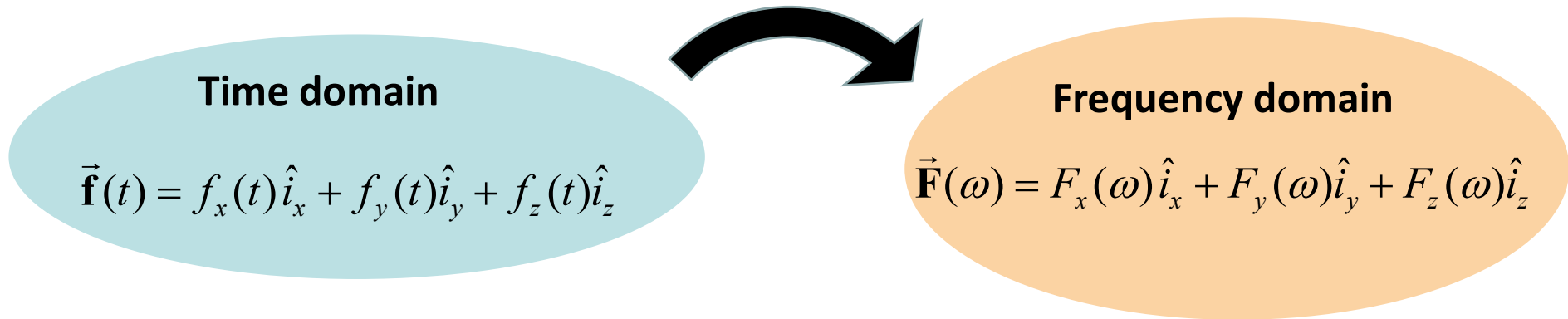

2) Time domain derivative and Fourier Transform

$$\vec{\mathbf{f}}(t) \longrightarrow \boxed{\text{FT}} \longrightarrow \vec{\mathbf{F}}(\omega)$$

$$\frac{d\vec{\mathbf{f}}(t)}{dt} \longrightarrow \boxed{\text{FT}} \longrightarrow ?$$

$$\frac{d\vec{\mathbf{f}}(t)}{dt} = \frac{df_x(t)}{dt}\hat{i}_x + \frac{df_y(t)}{dt}\hat{i}_y + \frac{df_z(t)}{dt}\hat{i}_z$$

$$\frac{df_x(t)}{dt} \longrightarrow \boxed{\text{1D-FT}} \longrightarrow j\omega F_x(\omega)$$

$$\frac{df_y(t)}{dt} \longrightarrow \boxed{\text{1D-FT}} \longrightarrow j\omega F_y(\omega)$$

$$\frac{df_z(t)}{dt} \longrightarrow \boxed{\text{1D-FT}} \longrightarrow j\omega F_z(\omega)$$

Fourier Transform and vector functions

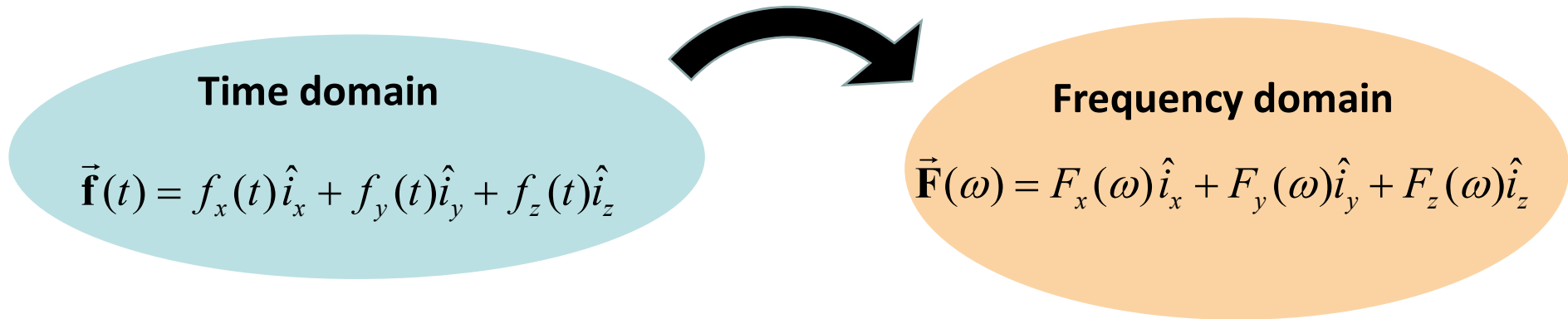

2) Time domain derivative and Fourier Transform

$$\vec{\mathbf{f}}(t) \longrightarrow \boxed{\text{FT}} \longrightarrow \vec{\mathbf{F}}(\omega)$$

$$\frac{d\vec{\mathbf{f}}(t)}{dt} \longrightarrow \boxed{\text{FT}} \longrightarrow j\omega F_x(\omega)\hat{i}_x + j\omega F_y(\omega)\hat{i}_y + j\omega F_z(\omega)\hat{i}_z$$

$$\frac{d\vec{\mathbf{f}}(t)}{dt} = \frac{df_x(t)}{dt}\hat{i}_x + \frac{df_y(t)}{dt}\hat{i}_y + \frac{df_z(t)}{dt}\hat{i}_z$$

$$\frac{df_x(t)}{dt} \longrightarrow \boxed{\text{1D-FT}} \longrightarrow j\omega F_x(\omega)$$

$$\frac{df_y(t)}{dt} \longrightarrow \boxed{\text{1D-FT}} \longrightarrow j\omega F_y(\omega)$$

$$\frac{df_z(t)}{dt} \longrightarrow \boxed{\text{1D-FT}} \longrightarrow j\omega F_z(\omega)$$

Fourier Transform and vector functions

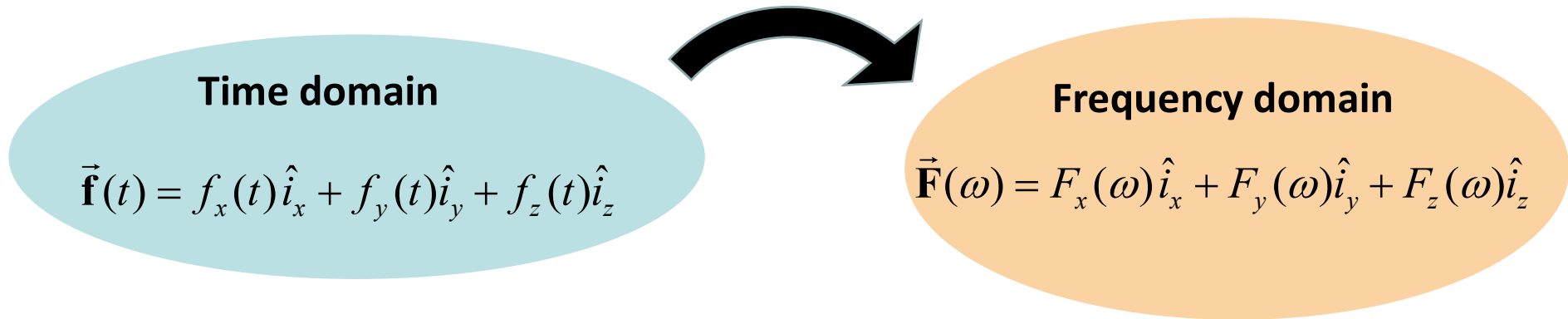

2) Time domain derivative and Fourier Transform

$$\vec{\mathbf{f}}(t) \longrightarrow \boxed{\text{FT}} \longrightarrow \vec{\mathbf{F}}(\omega)$$

$$\frac{d\vec{\mathbf{f}}(t)}{dt} \longrightarrow \boxed{\text{FT}} \longrightarrow j\omega\vec{\mathbf{F}}(\omega) = j\omega F_x(\omega)\hat{i}_x + j\omega F_y(\omega)\hat{i}_y + j\omega F_z(\omega)\hat{i}_z$$

$$\frac{d\vec{\mathbf{f}}(t)}{dt} = \frac{df_x(t)}{dt}\hat{i}_x + \frac{df_y(t)}{dt}\hat{i}_y + \frac{df_z(t)}{dt}\hat{i}_z$$

$$\frac{df_x(t)}{dt} \longrightarrow \boxed{\text{1D-FT}} \longrightarrow j\omega F_x(\omega)$$

$$\frac{df_y(t)}{dt} \longrightarrow \boxed{\text{1D-FT}} \longrightarrow j\omega F_y(\omega)$$

$$\frac{df_z(t)}{dt} \longrightarrow \boxed{\text{1D-FT}} \longrightarrow j\omega F_z(\omega)$$

Fourier Transform and vector functions

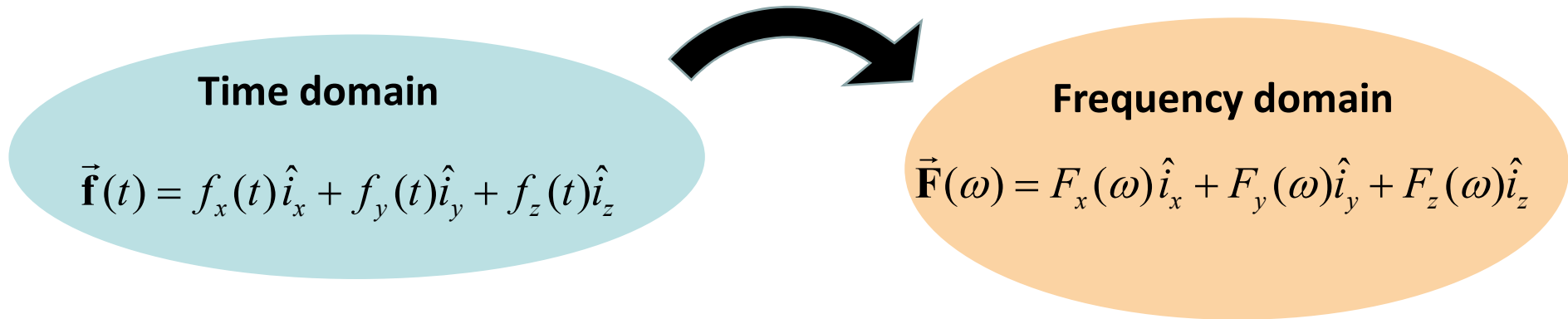

2) Time domain derivative and Fourier Transform

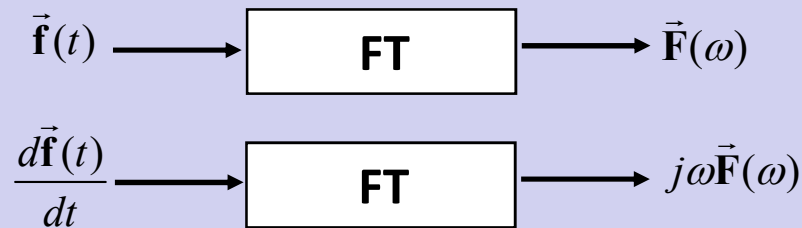

Frequency domain

- Fourier Transform and functions of n variables
- Fourier Transform and vector functions
- **Fourier Transform and vector functions of n variables**

- 1) How to jump back from the Frequency domain to the Time domain**
- 2) Time domain derivative and Fourier Transform**